

ROCKWOOD



ASSA ABLOY

Architectural Door Pulls



ASSA ABLOY, the global leader
in door opening solutions

Table of Contents

- 2. Standards (1" diameter pulls)
- 4. Tubular (1¼" & 1½" diameter pulls)
- 6. NeoMetrix™ (with GripZone™)
- 8. RightAngles™ (with or without GripZone™)
- 10. PostMount (straight & offset pulls)
- 12. NeoTek™ (post mounted GripZone™)
- 14. MegaTek™ (long door pulls)
- 16. NeoMax™ (long pulls with GripZone™)
- 18. MegaCurve™ (long curved pulls)
- 20. MezzoTek™ (necked post pulls)
- 22. BandWidth™ (collar mount pulls)
- 24. OvalTek™ (true oval grip)
- 26. OvalTek™ (flat oval grip)
- 28. NeoMitre™ (with or without GripZone™)
- 30. NeoCylinder™ (with or without GripZone™)
- 32. LineaMet™ (contrasting grooved pulls)
- 34. LineaTek™ (fully grooved pulls)
- 36. LineaMax™ (long grooved pulls)
- 38. NoirMet™ (black anodized grip)
- 40. NoirTek™ (black anodized grip)
- 42. ArborMet™ (wood grip pulls)
- 44. ArborTek™ (wood grip pulls)
- 46. SoftMet™ (Santoprene™ grip)
- 48. SoftTek™ (Santoprene™ grip)
- 50. IberMet™ (cork grips)
- 52. BronzeAge™ (copper rich grip)
- 54. SkewTek™ (angled end pulls & big pulls)
- 56. CenTek™ (1" radius pulls)
- 58. CenTrex™ (1" radius pulls)
- 60. CenTrex™ (large radius pulls)
- 62. GeoMetek™ (narrow profile pulls)
- 64. PlanTek™ (flat front pulls)
- 66. SculpTrex™ (shaped cast pulls)
- 68. SculpTrex™ (shaped cast pulls)
- 70. InfiniTrix™ (shaped cast pulls)
- 72. Traditional (decorative pulls & plates)
- 74. Classic (finial door pulls)
- 76. Edge Pulls (for closet doors)
- 77. Small Pulls (for cabinets, casework and closet doors)
- 78. Small PostMount Pulls (for cabinets, casework and closet doors)
- 79. Small PostMount Pulls (for cabinets, casework and closet doors)
- 80. Coat Hooks
- 81. Coat Hooks
- 82. Door Stops
- 83. Push Plates, Pull Plates & Signage
- 84. Custom Pivots
- 85. Custom Capabilities
- 86. Leather Craftsmanship General Information
- 88. English Bridal Leather (straight & offset pulls)
- 90. Upholstery Leather (straight & offset pulls)
- 92. Flush Leather (straight & offset pulls)
- 94. Leather Oval (ergonomic pulls)
- 96. Small Leather Pulls (for cabinets, casework and closet doors)
- 97. Custom Leather Applications

Copyright notices throughout the catalog refer to the proprietary designs on noted pages – all rights reserved



Company Focus: Rockwood is a leading manufacturer of architectural door trim hardware. Our main focus since our 1946 founding has been the design and fabrication of door pulls and other door trim products for commercial and fine residential buildings. These years of experience have been spent improving designs and efficiency so we are able to offer you outstanding product quality and value.

LEED Statement: When you select a Rockwood stainless steel door pull for your LEED certified building project you are using a product that is made from a minimum 75% post industrial waste and is 100% recyclable. Additionally these pulls can usually be refinished to their original appearance any time in the life of the building, eliminating the need for replacement when a renovation is conducted.

Finishes: Most products shown in our catalog are available in a wide variety of finishes. The photographs generally show only one finish for aesthetic reasons, but we make all traditional architectural finishes. The base metal from which we produce each product is indicated throughout the catalog and dictates what finishes are available.

Stainless Steel is one of the most durable materials used in architecture. However, there are many types of stainless steel with different properties and varying levels of corrosion resistance. In most indoor (except chlorine and other harsh chemical exposure locations) and many outdoor (mildly corrosive) environments our standard type 303/304 stainless steel will perform exceedingly well. It is best maintained with periodic water washing. If your job site has road salt, marine salt air, industrial or urban pollution, we recommend the use of molybdenum bearing 316 alloy stainless steel which is available on select products. Molybdenum significantly improves corrosion resistance, particularly resistance to salt corrosion. For more information see the International Molybdenum Association web site www.imoa.info. Specify Rockwood's US32**316** or US32D**316** for the very best performance.

In addition to stainless steel alloy selection, the surface finish of stainless steel has a big impact on its corrosion resistance. Minute particles of dirt and debris can lodge in the microscopic crevices of a satin finish (US32D/630) more readily than on a smooth surface (US32/629) therefore promoting corrosion. To enhance the corrosion resistance of any stainless steel, specify the polished version over the satin finish.

Fastening Systems: Three basic fastening systems are shown below. Most pulls are available in any of these three configurations. A specific bolt diameter and length will be provided for your particular application. The important aspect of a fastening system is that it attaches the pull solidly to the door and does not allow "play" between the pull and the door. Rockwood's mounting systems firmly attach the pull and are guaranteed for the life of the building.

Standard Mounting Details

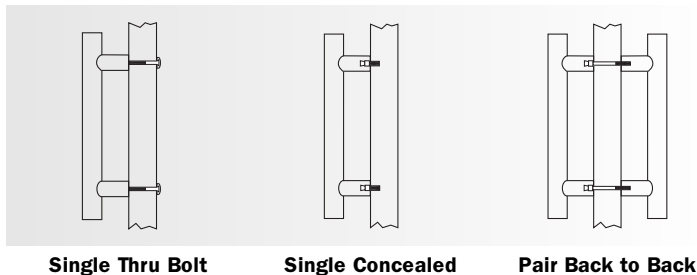

Optional base plates are an aesthetic and functional addition to most door pulls. The larger "foot print" of a base plate makes for added stability for the fastening system which is particularly important on glass and wood door mounted pulls. To add a base plate to any pull, suffix the product number with "Y" (example: RM3301Y); a base plate slightly larger than the pull diameter will be provided.

Custom Manufacturing: Rockwood can make the door hardware you want. Please don't hesitate to ask for minor design and size change to existing products or a completely custom creation. Our engineering department will work with you to create a solution to your requirement.

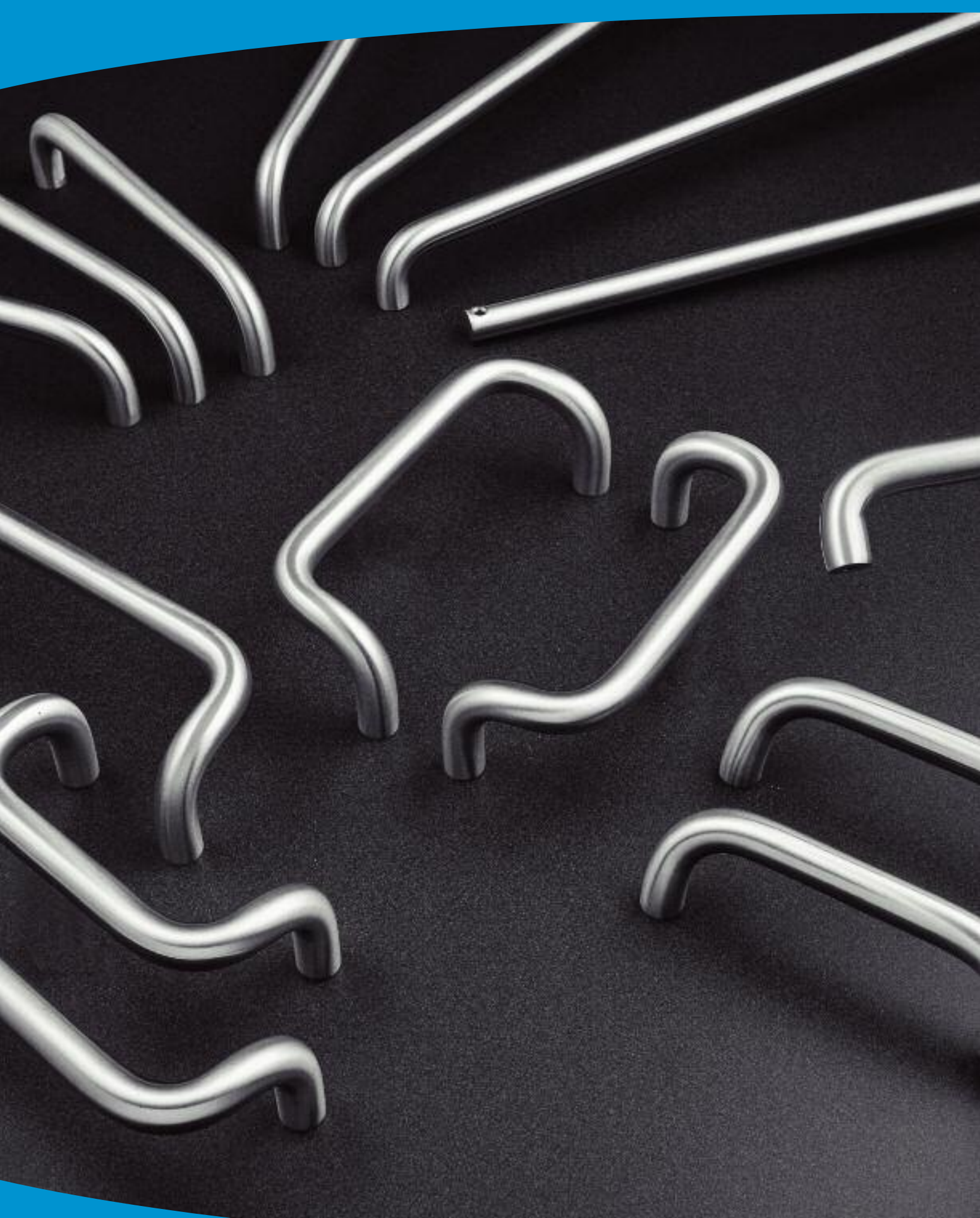

These one inch diameter push and pulls are the industry standard for contemporary design. Rockwood sets the benchmark for quality and value in this product category. Our offset pulls come with a 2½" clearance for enhanced ADA compliance. Use two or three push bars on a door as an attractive design element and increased usability for people of all heights.

Standards

1" diameter pulls

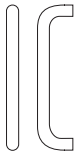

Straight Pulls

Pull No.	CTC
110	8"
111A	9"
111	10"
112	12"
118	18"

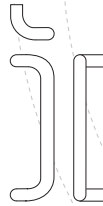

90° Offset Pulls

Pull No.	CTC
BF156	8"
BF157A	9"
BF157	10"
BF158	12"
BF159	18"

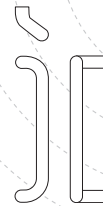

45° Offset Pulls

Pull No.	CTC
BF166	8"
BF167A	9"
BF167	10"
BF168	12"
BF169	18"

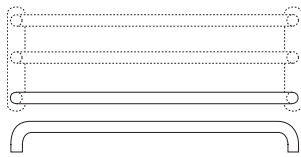
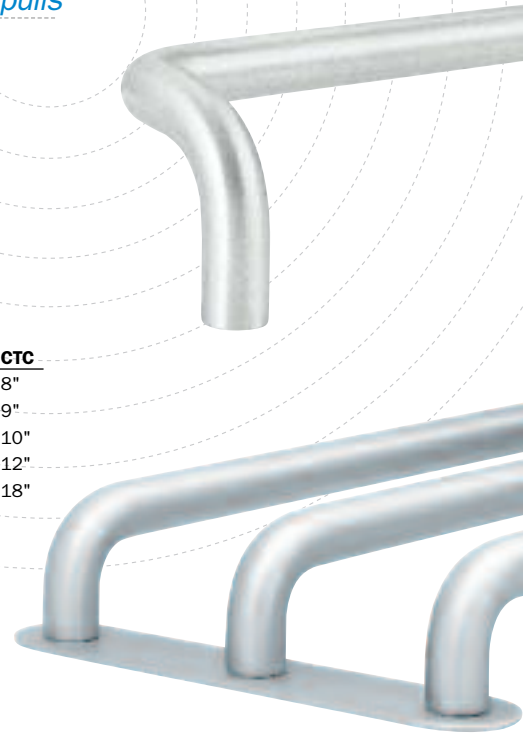

Push Bars (shown with optional base plate)*

Pull No.	Pull CTC	Base Plate
47	Specify	No
BP47	Specify	Yes



Single Projection Push Bar

Pull No.	CTC
SP47	Specify

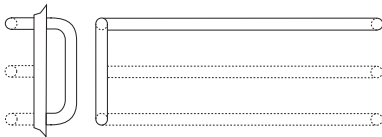

Straight Push Pull Sets*

Pull No.	Pull CTC	Bar CTC
11047	8"	Specify
111A47	9"	Specify
11147	10"	Specify
11247	12"	Specify

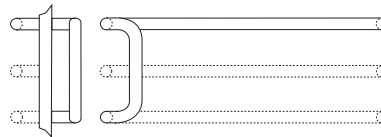

Offset Push Pull Sets*

Pull No.	Pull CTC	Bar CTC
BF15647	8"	Specify
BF157A47	9"	Specify
BF15747	10"	Specify
BF15847	12"	Specify

Base Metals: Aluminum, brass, bronze, stainless steel

*To specify multi-bar sets suffix -2 or -3 to pull number (example: BF15647-3).

Note: Phantom lines depict optional multi-bar sets.



Our 1¼" and 1½" diameter tubular pulls and pushes are made from rugged 16-gauge wall tubing with solid brass end inserts. These large diameter pulls provide a greater door contact area (1¼" pulls have 60% larger and 1½" pulls have 125% larger mounting area) than 1" pulls, which ensures that Rockwood's guaranteed fastening system will provide a tight permanent installation. Our RM257 series is made from solid 1¼" rod and its 30° angle cut provides a mounting footprint 80% larger than 1" pulls.

Tubular

1¼" & 1½" diameter pulls

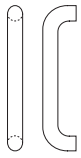

Straight Pulls

Pull No.	Diameter	CTC
RM301	1¼"	12"
RM302	1¼"	18"
RM303	1¼"	24"
RM304	1¼"	36"
RM321	1½"	12"
RM322	1½"	18"
RM323	1½"	24"
RM324	1½"	36"

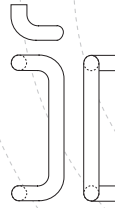

Offset Pulls

Pull No.	Diameter	CTC
RM201	1¼"	12"
RM202	1¼"	18"
RM203	1¼"	24"
RM204	1¼"	36"
RM221	1½"	12"
RM222	1½"	18"
RM223	1½"	24"
RM224	1½"	36"

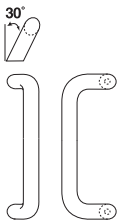

Angle Pulls - Solid

Pull No.	Diameter	CTC
RM257	1¼"	10"
RM258	1¼"	12"
RM259	1¼"	18"

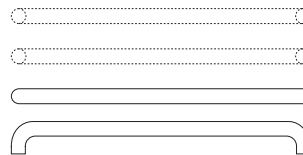

Push Bars*

Pull No.	Diameter	CTC
RM350	1¼"	Specify
RM370	1½"	Specify

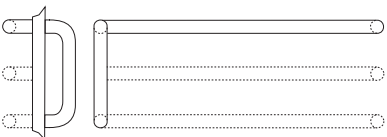

Straight Push Pull Sets*

Pull No.	Diameter	Pull CTC	Bar CTC
RM351	1¼"	12"	Specify
RM352	1¼"	18"	Specify
RM371	1½"	12"	Specify
RM372	1½"	18"	Specify

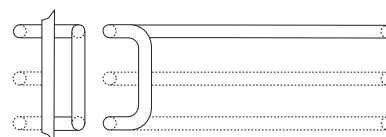

Offset Push Pull Sets*

Pull No.	Diameter	Pull CTC	Bar CTC
RM251	1¼"	12"	Specify
RM252	1¼"	18"	Specify
RM271	1½"	12"	Specify
RM272	1½"	18"	Specify

Base Metals: Aluminum, brass, bronze, stainless steel

*To specify multi-bar sets suffix -2 or -3 to pull number (example: RM350-3).

Note: Phantom lines depict optional multi-bar sets.



The NeoMetrix line features GripZone — a satin finished grip area contrasting to the bright mirror finish at the ends. Not only visually appealing, this winning design is practical as well. The satin finish contact area hides small marks and scratches caused by rings, jewelry, and keys. On push bars, the GripZone identifies which side of the door swings open.

NeoMetrix™
with GripZone™

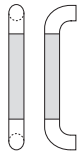

Straight Pulls

Pull No.	Diameter	CTC
RM3010	1"	12", 18"
RM3020	1½"	12", 18", 24"
RM3030	1½"	12", 18", 24"

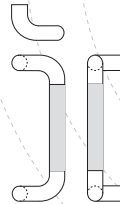

Offset Pulls

Pull No.	Diameter	CTC
RM3040	1"	12", 18"
RM3050	1½"	12", 18", 24"
RM3060	1½"	12", 18", 24"

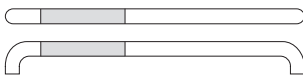
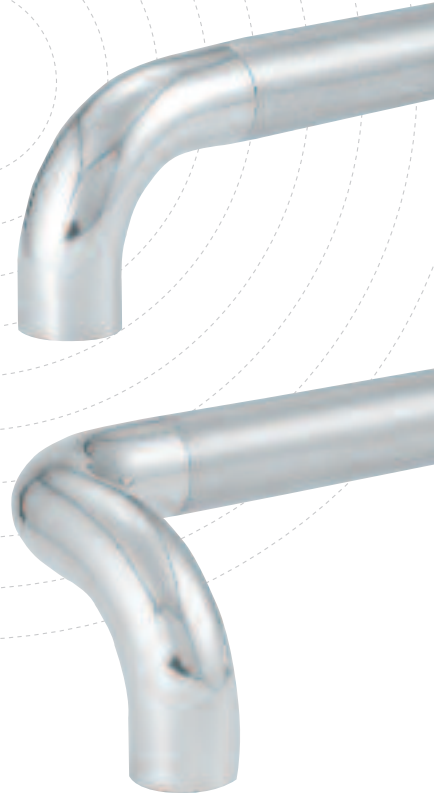

Push Bars*

Pull No.	Diameter	CTC
RM3012	1"	Specify
RM3022	1½"	Specify
RM3032	1½"	Specify

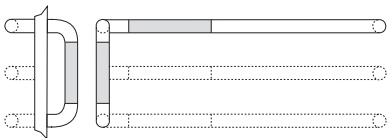

Straight Push Pull Sets*

Pull No.	Diameter	Pull CTC	Bar CTC
RM3015	1"	12"	Specify
RM3025	1½"	12"	Specify
RM3035	1½"	12"	Specify

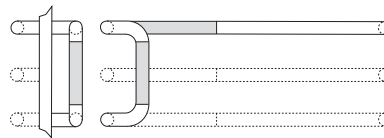

Offset Push Pull Sets*

Pull No.	Diameter	Pull CTC	Bar CTC
RM3045	1"	12"	Specify
RM3055	1½"	12"	Specify
RM3065	1½"	12"	Specify

Base Metals: Brass, bronze, stainless steel

*To specify multi-bar sets suffix -2 or -3 to pull number (example: RM3015-2).

Note: Phantom lines depict optional multi-bar sets.



These right angle push and pulls offer a solution to matching glass door exit devices as well as being a design statement of their own. The extra gripping area provided by the horizontal and vertical sections make it a universally usable pull and push bar. Standard diameter is 1 1/4"; other diameters are available.

RightAngles™
with or without GripZone™

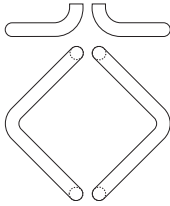
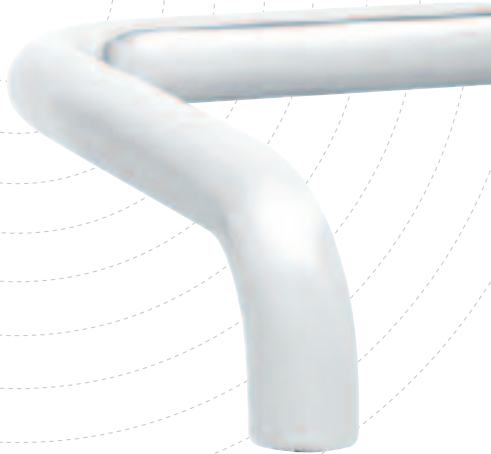

Angle Pull

Pull No.	CTC
RM405-15	15"

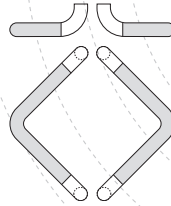

Angle Pull with GripZone

Pull No.	CTC
RM415-15	15"

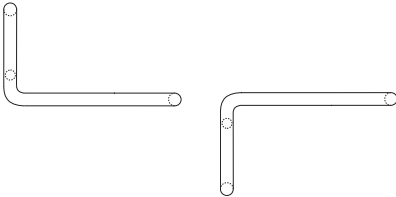

Short Angle Push Pulls

Pull No.	CTC
RM410 (leg up)	Specify Height x Width
RM411 (leg down)	Specify Height x Width

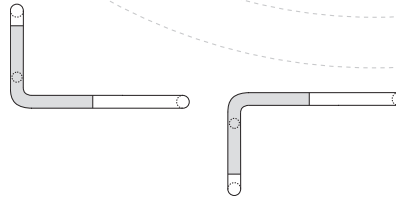

Short Angle Push Pulls with GripZone

Pull No.	CTC
RM420 (leg up)	Specify Height x Width
RM421 (leg down)	Specify Height x Width

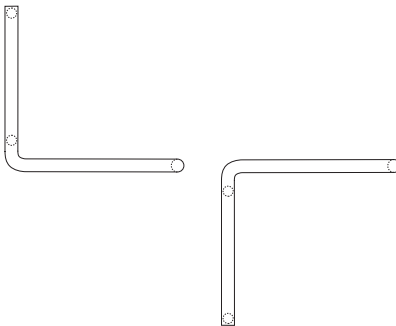

Long Angle Push Pulls

Pull No.	CTC
RM412 (leg up)	Specify Height x Width
RM413 (leg down)	Specify Height x Width

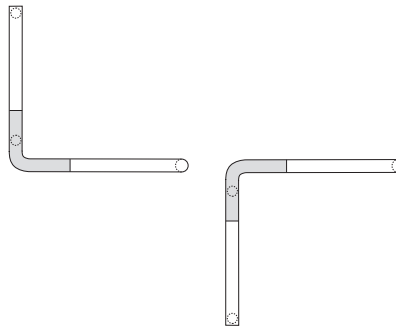

Long Angle Push Pulls with GripZone

Pull No.	CTC
RM422 (leg up)	Specify Height x Width
RM423 (leg down)	Specify Height x Width

Application Suggestion

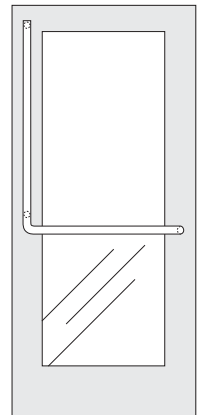



Post mounted pulls are smart, clean designs for all kinds of doors. Offset mounting bases allow this group to be used on narrow style doors. Square and round end versions are available as well as custom lengths. The simplicity of this group is an attribute that adds contemporary beauty to even standard entrance doors. See the price list for push pull sets.

PostMount

straight & offset pulls

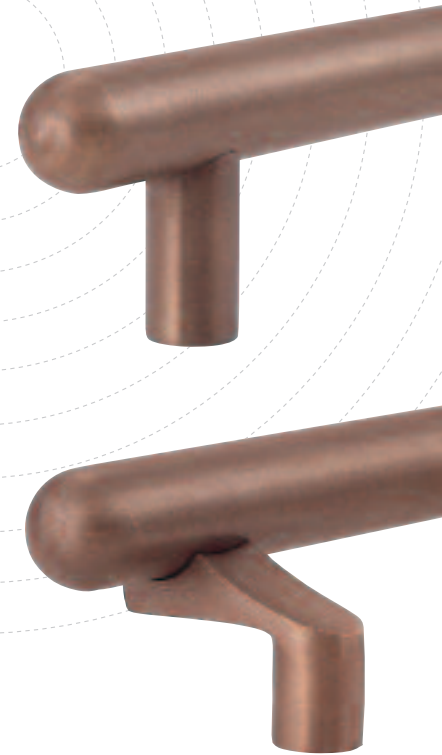

Straight Pulls - Square Ends

Pull No.	Diameter	CTC
RM3100	1"	8", 10", 12"
RM3110	1½"	8", 11", 16"
RM3120	1½"	11", 16", 20"

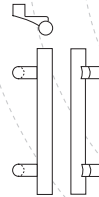

Offset Pulls - Square Ends

Pull No.	Diameter	CTC
RM3130	1"	8", 10", 12"
RM3140	1½"	8", 11", 16"
RM3150	1½"	11", 16", 20"



Straight Pulls - Round Ends

Pull No.	Diameter	CTC
RM3104	1"	8", 10", 12"
RM3114	1½"	8", 11", 16"
RM3124	1½"	11", 16", 20"

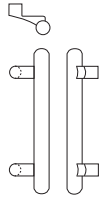

Offset Pulls - Round Ends

Pull No.	Diameter	CTC
RM3134	1"	8", 10", 12"
RM3144	1½"	8", 11", 16"
RM3154	1½"	11", 16", 20"

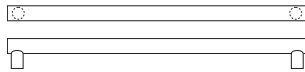

Push Bars - Square Ends*

Pull No.	Diameter	CTC
RM3102	1"	Specify
RM3112	1½"	Specify
RM3122	1½"	Specify

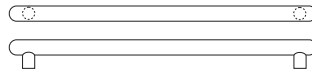

Push Bars - Round Ends*

Pull No.	Diameter	CTC
RM3106	1"	Specify
RM3116	1½"	Specify
RM3126	1½"	Specify

Base Metals: Aluminum (except offset pulls), brass, bronze, stainless steel

*To specify multi-bar sets suffix -2 or -3 to pull number (example: RM3112-3).



NeoTek post mounted door pulls and push bars meld the durable and attractive GripZone finish with a contemporary post mounted style. Both straight and offset pulls in square and round end versions are available in three diameters. Custom lengths are readily available. See price list for push pull sets.

NeoTek™
post mounted GripZone™

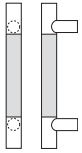

Straight Pulls - Square Ends

Pull No.	Diameter	CTC
RM3200	1"	8", 10", 12"
RM3210	1½"	8", 11", 16"
RM3220	1½"	11", 16", 20"

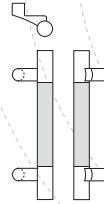

Offset Pulls - Square Ends

Pull No.	Diameter	CTC
RM3230	1"	8", 10", 12"
RM3240	1½"	8", 11", 16"
RM3250	1½"	11", 16", 20"

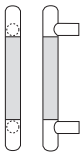

Straight Pulls - Round Ends

Pull No.	Diameter	CTC
RM3204	1"	8", 10", 12"
RM3214	1½"	8", 11", 16"
RM3224	1½"	11", 16", 20"

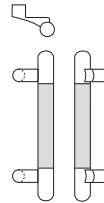

Offset Pulls - Round Ends

Pull No.	Diameter	CTC
RM3234	1"	8", 10", 12"
RM3244	1½"	8", 11", 16"
RM3254	1½"	11", 16", 20"



Push Bars - Square Ends*

Pull No.	Diameter	CTC
RM3202	1"	Specify
RM3212	1½"	Specify
RM3222	1½"	Specify

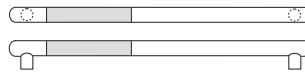

Push Bars - Round Ends*

Pull No.	Diameter	CTC
RM3206	1"	Specify
RM3216	1½"	Specify
RM3226	1½"	Specify



Base Metals: Brass, bronze, stainless steel
Note: See price list for information on ordering push pull sets.

*To specify multi-bar sets suffix -2 or -3 to pull number (example: RM3202-3).



Long door pulls are an artful and functional solution for any door. We offer both straight and offset versions. Most often used as full height, these pulls are available in three diameters and any length from 3 feet to over 8 feet long; see price list for more information. Specify a mid-post on full height pulls to provide the most rigid grip where heavy doors or high wind loads are present.

MegaTek™
long door pulls

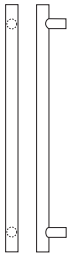

Straight Pulls - Square Ends

Pull No.	Diameter	CTC
RM3300	1"	36" to 96"
RM3301	1¼"	36" to 96"
RM3302	1½"	36" to 96"

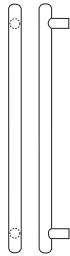

Straight Pulls - Round Ends

Pull No.	Diameter	CTC
RM3320	1"	36" to 96"
RM3321	1¼"	36" to 96"
RM3322	1½"	36" to 96"



Straight Pulls - Bent Ends

Pull No.	Diameter	CTC
RM3340	1"	36" to 96"
RM3341	1¼"	36" to 96"
RM3342	1½"	36" to 96"

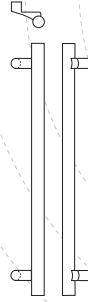

Offset Pulls - Square Ends

Pull No.	Diameter	CTC
RM3310	1"	36" to 96"
RM3311	1¼"	36" to 96"
RM3312	1½"	36" to 96"

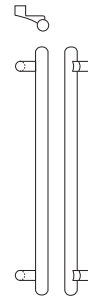

Offset Pulls - Round Ends

Pull No.	Diameter	CTC
RM3330	1"	36" to 96"
RM3331	1¼"	36" to 96"
RM3332	1½"	36" to 96"

Application Suggestions

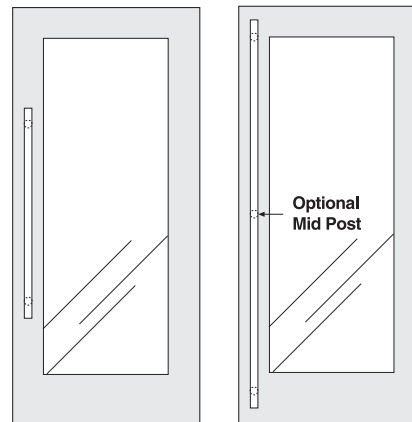

Base Metals: Aluminum (except offset models), brass, bronze, stainless steel

Options: • For optional mid-post, suffix the product number with "MP" (example: RM3301MP).
• Over 96" available on select finishes.



The beauty of long door pulls is enhanced with the contrasting finish of our NeoMax line. This smart, visually appealing GripZone design makes a welcome addition to any door. Any length may be made to order from 3 feet to over 8 feet long; see price list for more information. Specify a mid-post on full height pulls to provide the most rigid grip where heavy doors or high wind loads are present.

NeoMax™
long pulls with GripZone™

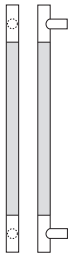

Straight Pulls - Square Ends

Pull No.	Diameter	CTC
RM3400	1"	36" to 96"
RM3401	1½"	36" to 96"
RM3402	1½"	36" to 96"

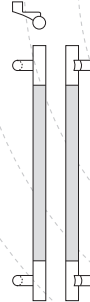

Offset Pulls - Square Ends

Pull No.	Diameter	CTC
RM3410	1"	36" to 96"
RM3411	1½"	36" to 96"
RM3412	1½"	36" to 96"

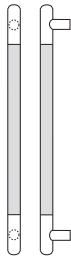

Straight Pulls - Round Ends

Pull No.	Diameter	CTC
RM3420	1"	36" to 96"
RM3421	1½"	36" to 96"
RM3422	1½"	36" to 96"

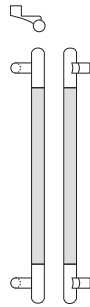

Offset Pulls - Round Ends

Pull No.	Diameter	CTC
RM3430	1"	36" to 96"
RM3431	1½"	36" to 96"
RM3432	1½"	36" to 96"

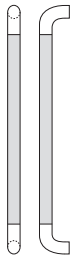

Straight Pulls - Bent Ends

Pull No.	Diameter	CTC
RM3440	1"	36" to 96"
RM3441	1½"	36" to 96"
RM3442	1½"	36" to 96"

Application Suggestions

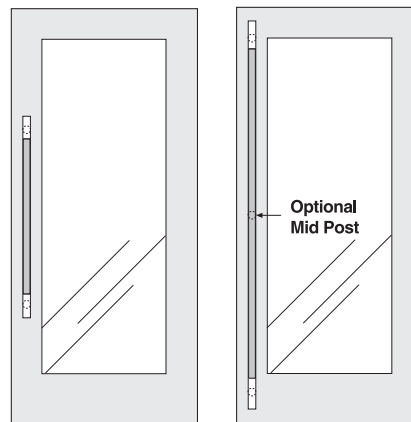

Base Metals: Brass, bronze, stainless steel

- Options:**
- For optional mid-post, suffix the product number with "MP" (example: RM3401MP).
 - Over 96" available on select finishes.



Ever since the discovery of calculus by Sir Isaac Newton and Gottfried Leibniz in the 17th century, man has been fascinated with the building of precise curved surfaces. Rockwood is eager to build the curved pull you envision. Select from the standard shapes shown here in 1½" diameter or send a drawing of your own.

MegaCurve™
long curved pulls

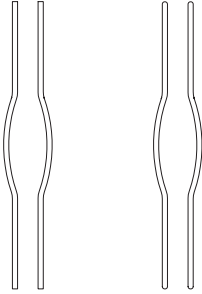

Mid Bow Pulls

Pull No.	End	Diameter	CTC
RM2000	Square	1½"	72" to 96"
RM2004	Round	1½"	72" to 96"

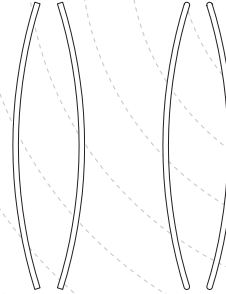

Long Bow Pulls

Pull No.	End	Diameter	CTC
RM2010	Square	1½"	72" to 96"
RM2014	Round	1½"	72" to 96"

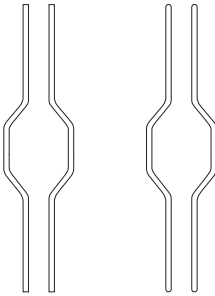

45 Degree Pulls

Pull No.	End	Diameter	CTC
RM2020	Square	1½"	72" to 96"
RM2024	Round	1½"	72" to 96"

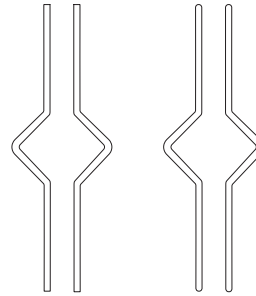

Triangle Pulls

Pull No.	End	Diameter	CTC
RM2030	Square	1½"	72" to 96"
RM2034	Round	1½"	72" to 96"



Application Suggestions

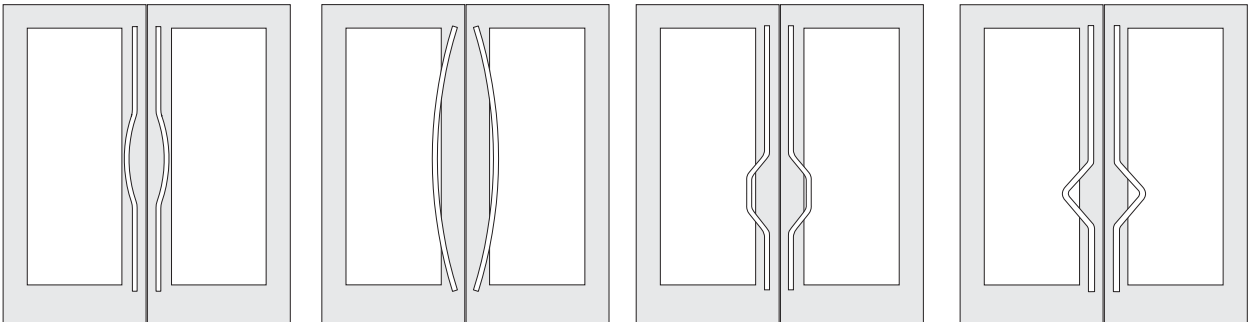

Base Metals: Brass, bronze, stainless steel
Options: Over 96" available on select finishes.

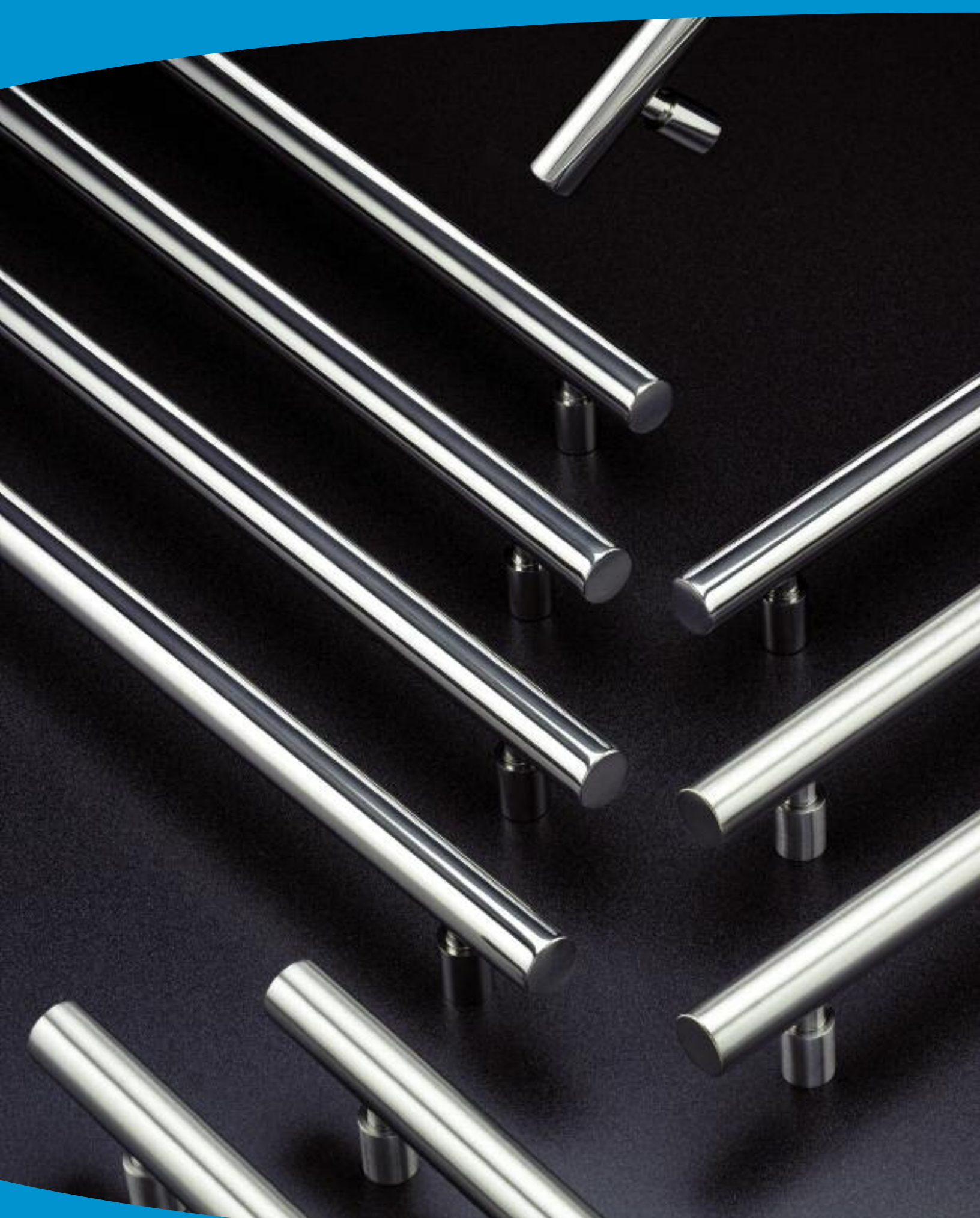

MezzoTek pulls appear to float on necked posts yet are made with Rockwood's unique sturdy construction. Available in most architectural finishes in 1¼" and 1½" diameter pulls and push bars. Full height pulls are available as well. Our popular GripZone contrasting finish is available as shown in the drawings and detail photograph.

MezzoTek™
with or without GripZone™

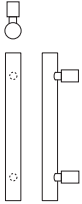

Straight Pulls

Pull No.	Diameter	CTC
RM2110	1¼"	8", 11", 16"
RM2120	1½"	11", 16", 20"

Up to 96" CTC available.

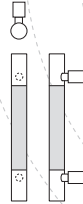

Straight Pulls

Pull No.	Diameter	CTC
RM2130	1¼"	8", 11", 16"
RM2140	1½"	11", 16", 20"

Up to 96" CTC available.

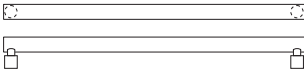

Push Bars*

Pull No.	Diameter	CTC
RM2112	1¼"	Specify
RM2122	1½"	Specify

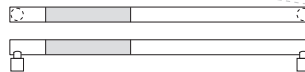

Push Bars*

Pull No.	Diameter	CTC
RM2132	1¼"	Specify
RM2142	1½"	Specify

Application Suggestions

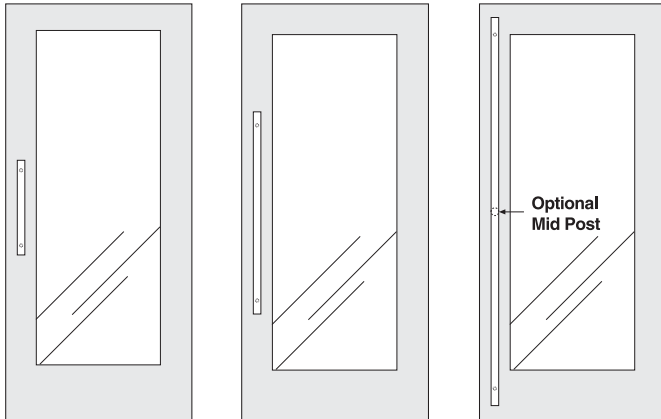

Base Metals: Brass, bronze, stainless steel

- Options:**
- For optional mid-post, suffix the product number with "MP" (example: RM2120MP).
 - Over 96" available on select finishes.

*To specify multi-bar sets suffix -2 or -3 to pull number (example: RM2132-3).



BandWidth design features a collar that attaches the grip section to the mounting posts. The collar can be furnished in a matching finish and base metal, or any combination of contrasting finishes of similar or dissimilar metals. Black anodized aluminum grips create a visual effect similar to our NoirMet pulls. The detail photo shows an un-lacquered bronze grip that provides the rich copper color and patina potential associated with copper alloys. Round end versions add an extra element of interest.

BandWidth™
collar mount pulls

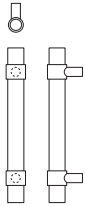

Straight Pulls - Square Ends

Pull No.	Diameter	CTC
RM2200	1"	8", 10", 12"
RM2210	1½"	8", 11", 16"

Up to 96" CTC available.

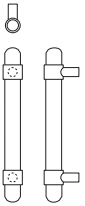

Straight Pulls - Round Ends

Pull No.	Diameter	CTC
RM2204	1"	8", 10", 12"
RM2214	1½"	8", 11", 16"

Up to 96" CTC available.

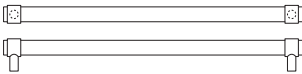

Push Bars - Square Ends

Pull No.	Diameter	CTC
RM2202	1"	Specify
RM2212	1½"	Specify

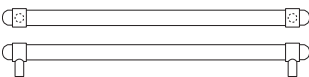

Push Bars - Round Ends

Pull No.	Diameter	CTC
RM2206	1"	Specify
RM2216	1½"	Specify

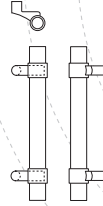

Offset Pulls - Square Ends

Pull No.	Diameter	CTC
RM2230	1"	8", 10", 12"
RM2240	1½"	8", 11", 16"

Up to 96" CTC available.

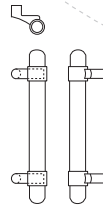

Offset Pulls - Round Ends

Pull No.	Diameter	CTC
RM2234	1"	8", 10", 12"
RM2244	1½"	8", 11", 16"

Up to 96" CTC available.

Application Suggestions

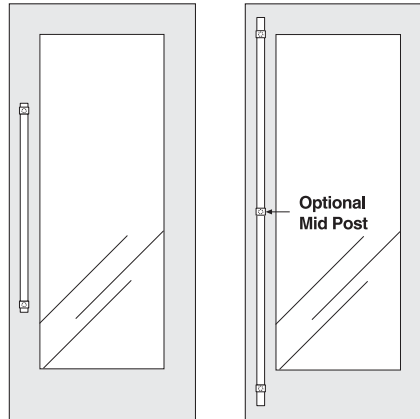

Other Length Ordering Options

Full length BandWidth pulls are available in both straight and offset versions from 3 feet to over 8 feet long.

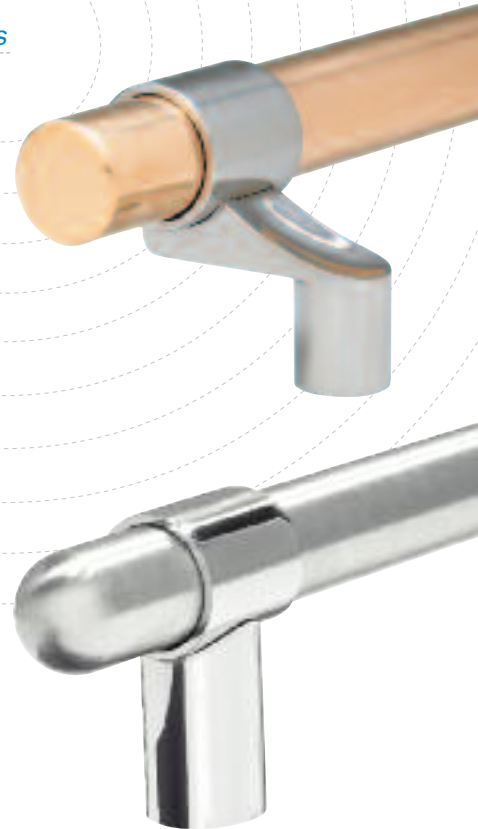

Base Metals: Aluminum (grip only), brass, bronze, stainless steel

Options:

- For optional mid-post, suffix the product number with "MP" (example: RM2210MP).
- Over 96" available on select finishes.



The grip of our oval shape conforms to the natural contour of one's hand, defining the standard in comfort for the user. The design is complimented by the oval shaped mounting posts. The pulls are available in regular and full height lengths. The push bar features oval tubing practically positioned to expose the broad pushing surface. Available in two cross section sizes, the oval pulls and push bars are the most ergonomically correct door hardware.

OvalTek™
with true oval grip

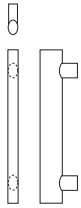

Straight Oval Pulls

Pull No.	Size	CTC
RM2300	1" x 1½"	8", 11", 16"
RM2310	1" x 1¼"	11", 16", 20"

Up to 96" CTC available.

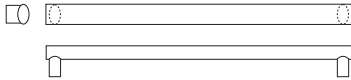

Push Bars

Pull No.	Size	CTC
RM2302	1" x 1½"	Specify
RM2312	1" x 1¼"	Specify

Application Suggestions

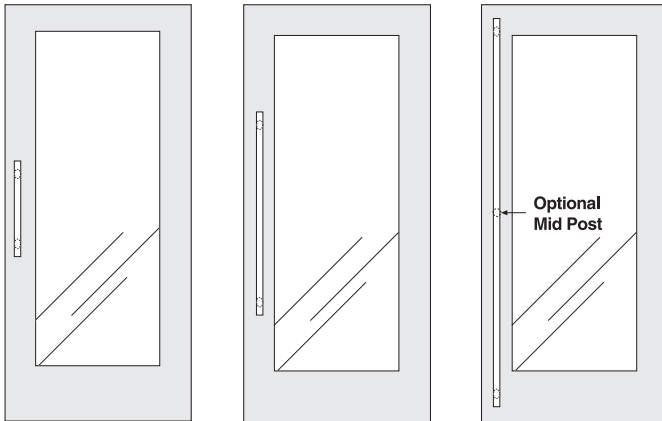

Base Metal: Stainless steel

Options: • For optional mid-post, suffix the product number with "MP" (example: RM2310MP).
• Over 96" available on select finishes.

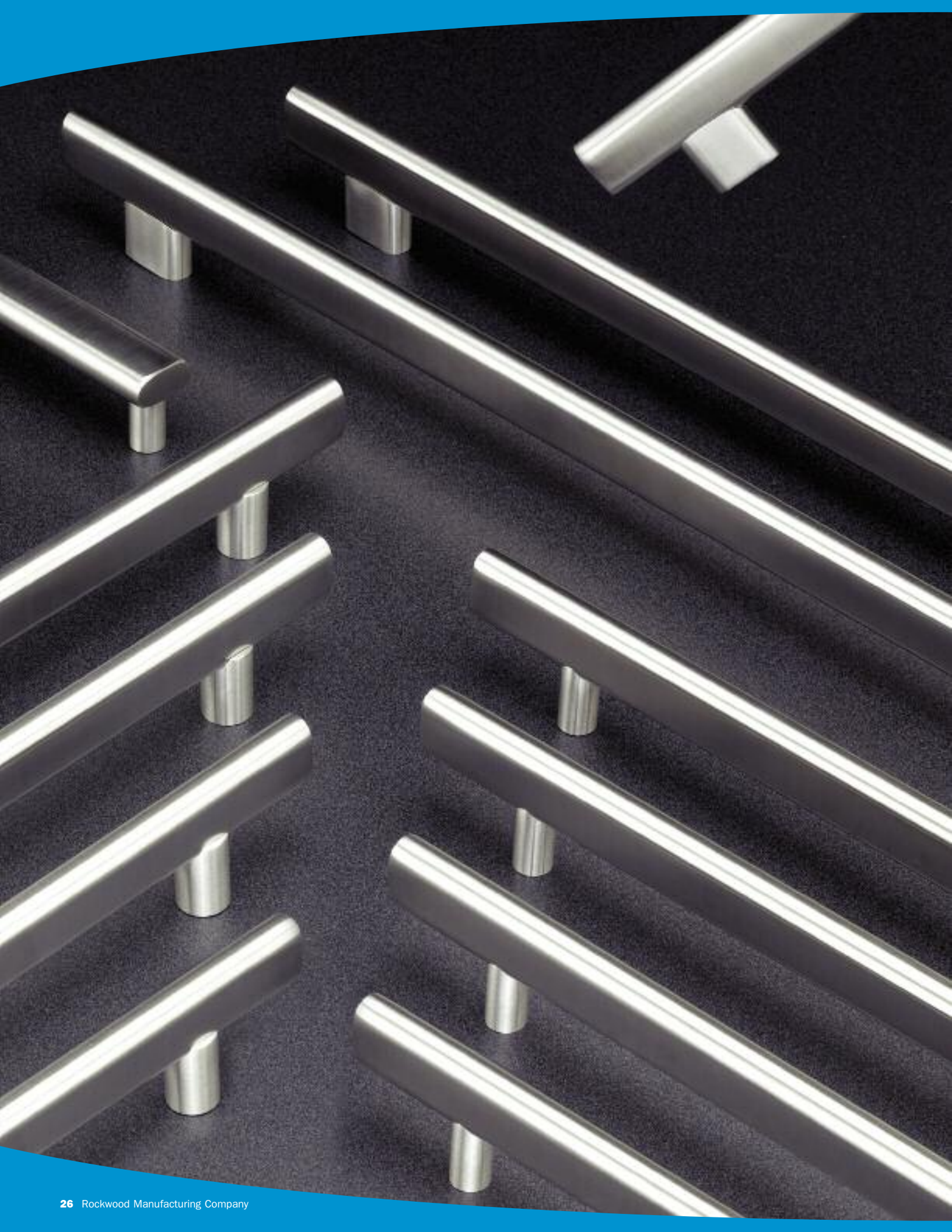

The comfortable and attractive ¾" x 1½" flat oval shape is available with three styles of mounting posts and in full-length versions. This sturdy, sleek shape creates a beautiful pull and is available with a leather cover shown on page 95. Flat oval combines the ergonomics of the true oval with the trim lines of rectangular tubing.

OvalTek™
with flat oval grip

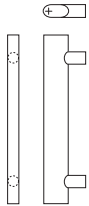

Straight Pull - ¾" Round Post

Pull No.	Size	CTC
RM2400	¾" x 1½"	8", 11", 16"

Up to 96" CTC available.

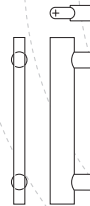

Straight Pull - 1" Round Post

Pull No.	Size	CTC
RM2410	¾" x 1½"	8", 11", 16"

Up to 96" CTC available.

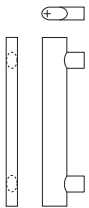

Straight Pull - Oblong Post

Pull No.	Size	CTC
RM2420	¾" x 1½"	8", 11", 16"

Up to 96" CTC available.

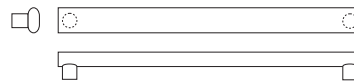

Push Bar

Pull No.	Size	CTC
RM2402	¾" x 1½"	Specify

Application Suggestions

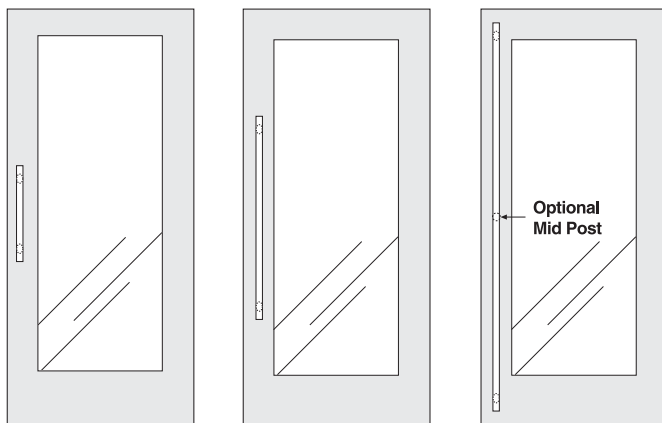

Base Metal: Stainless steel

Options: • For optional mid-post, suffix the product number with "MP" (example: RM2420MP).
• Over 96" available on select finishes.

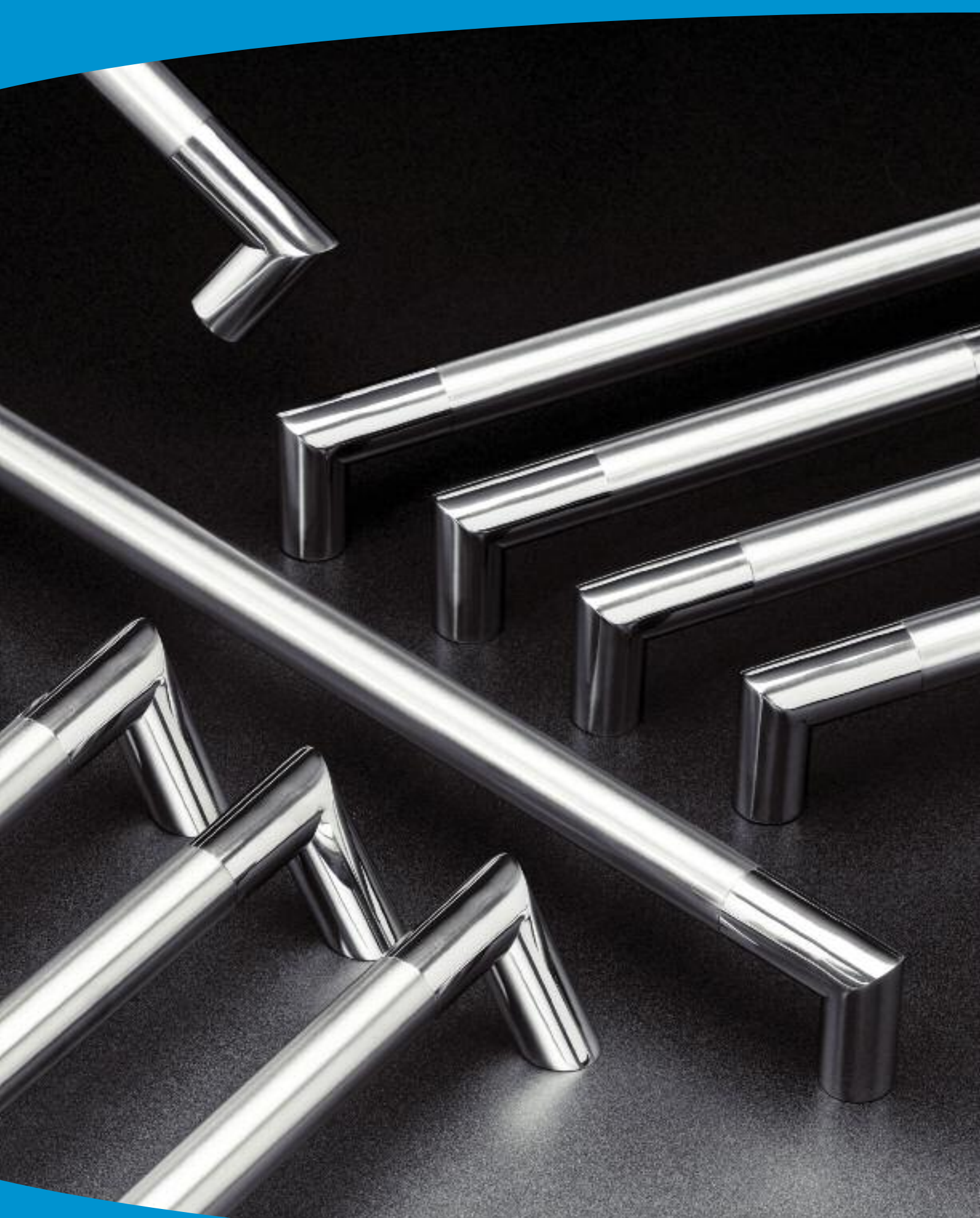

Rockwood mitre pulls are fabricated by a precise process that accomplishes the joint without any sign of welding residue. The GripZone feature of NeoMitre adds appeal to the design. Beyond providing an attractive contrast, the satin finish contact area conceals small scratches caused by routine use. Available in three diameters and custom lengths.

NeoMitre™
with or without GripZone™



Straight Pulls

Pull No.	Diameter	CTC
RM7300	1"	8", 11", 16"
RM7310	1½"	11", 16", 20"
RM7320	1½"	11", 16", 20"

Up to 36" CTC available.

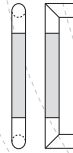

Straight Pulls

Pull No.	Diameter	CTC
RM7400	1"	8", 11", 16"
RM7410	1½"	11", 16", 20"
RM7420	1½"	11", 16", 20"

Up to 36" CTC available.

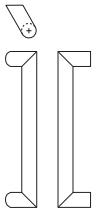

Offset Pulls

Pull No.	Diameter	CTC
RM7330	1"	8", 11", 16"
RM7340	1½"	11", 16", 20"
RM7350	1½"	11", 16", 20"

Up to 36" CTC available.

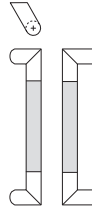

Offset Pulls

Pull No.	Diameter	CTC
RM7430	1"	8", 11", 16"
RM7440	1½"	11", 16", 20"
RM7450	1½"	11", 16", 20"

Up to 36" CTC available.

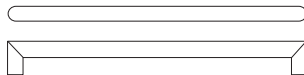

Push Bars*

Pull No.	Diameter	CTC
RM7302	1"	Specify
RM7312	1½"	Specify
RM7322	1½"	Specify

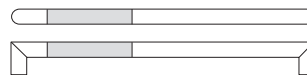

Push Bars*

Pull No.	Diameter	CTC
RM7402	1"	Specify
RM7412	1½"	Specify
RM7422	1½"	Specify

Application Suggestions

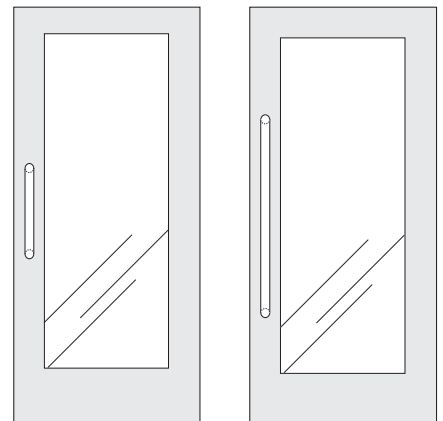

Base Metal: Stainless steel

*To specify multi-bar sets suffix -2 or -3 to pull number (example: RM7302-2).

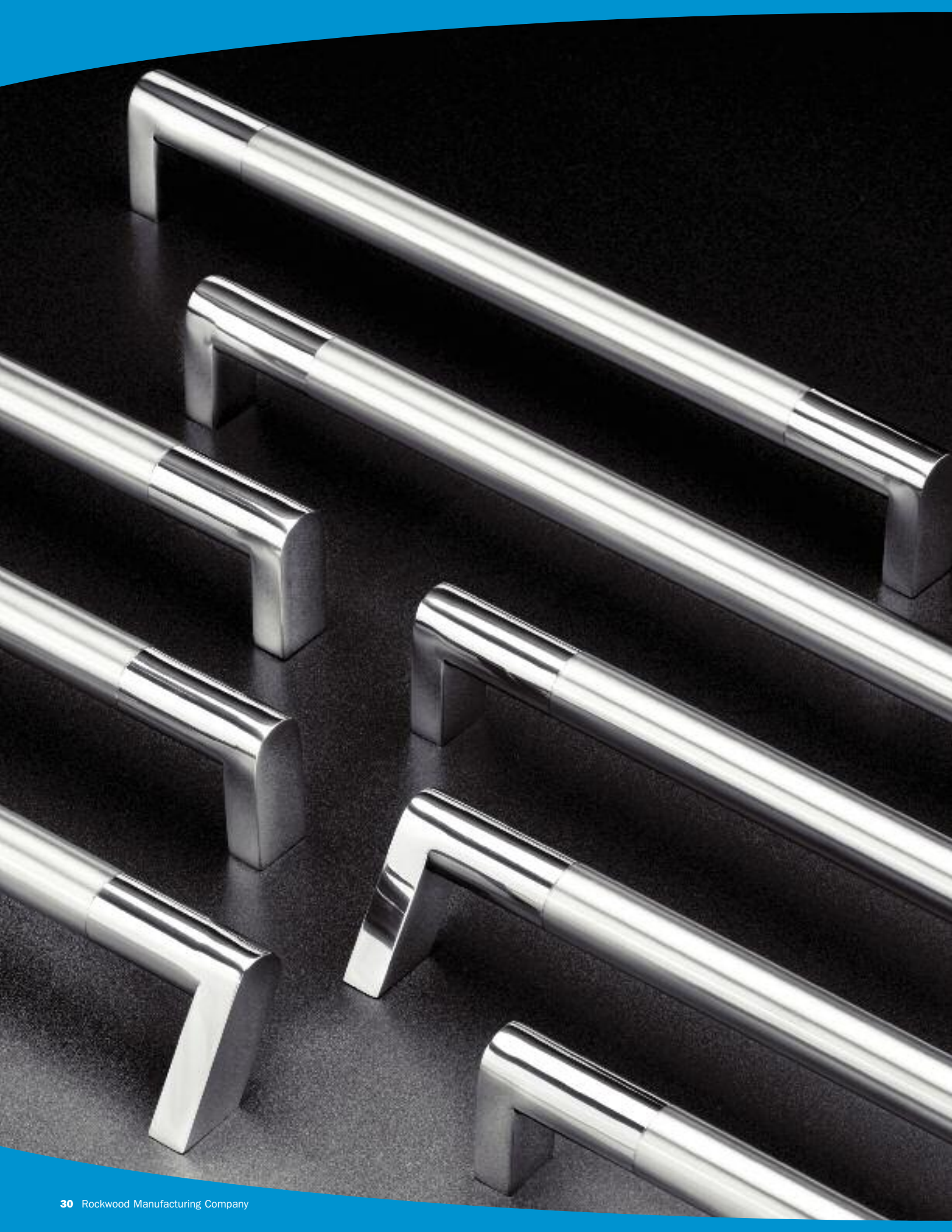

The fresh design of our Cylinder Pull is available in straight and offset versions. The 1¼" tubing blends seamlessly into the terminating flat end posts. NeoCylinder Pulls are available with our popular GripZone finish.

NeoCylinder™
with or without GripZone™



Straight Pull

Pull No.	Diameter	CTC
RM7210	1¼"	11", 16", 20"

Up to 36" CTC available.

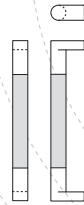

Straight Pull

Pull No.	Diameter	CTC
RM7230	1¼"	11", 16", 20"

Up to 36" CTC available.

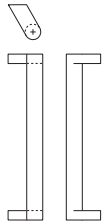

Offset Pull

Pull No.	Diameter	CTC
RM7220	1¼"	11", 16", 20"

Up to 36" CTC available.

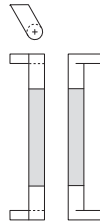

Offset Pull

Pull No.	Diameter	CTC
RM7240	1¼"	11", 16", 20"

Up to 36" CTC available.

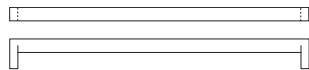

Push Bar

Pull No.	Diameter	CTC
RM7212	1¼"	Specify

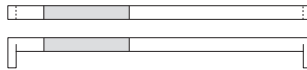

Push Bar

Pull No.	Diameter	CTC
RM7232	1¼"	Specify

Base Metal: Stainless steel



The LineaMet design group utilizes Rockwood's grooved tubing in a unique contemporary fashion. Precisely fitted joints make a smooth transition between the solid ends and the grooved tubing. Available in two diameters and a variety of lengths and finishes.

LineaMet™
contrasting grooved pulls

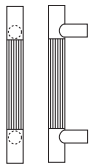

Straight Pulls - Square Ends

Pull No.	Diameter	CTC
RM3510	1½"	8", 11", 16"
RM3520	1½"	11", 16", 20"

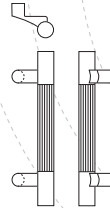

Offset Pulls - Square Ends

Pull No.	Diameter	CTC
RM3540	1½"	8", 11", 16"
RM3550	1½"	11", 16", 20"

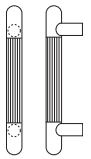

Straight Pulls - Round Ends

Pull No.	Diameter	CTC
RM3514	1½"	8", 11", 16"
RM3524	1½"	11", 16", 20"

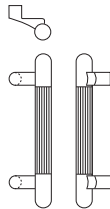

Offset Pulls - Round Ends

Pull No.	Diameter	CTC
RM3544	1½"	8", 11", 16"
RM3554	1½"	11", 16", 20"



Push Bars - Square Ends*

Pull No.	Diameter	CTC
RM3512	1½"	Specify
RM3522	1½"	Specify

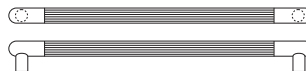

Push Bars - Round Ends*

Pull No.	Diameter	CTC
RM3516	1½"	Specify
RM3526	1½"	Specify

Base Metals: Brass, bronze, stainless steel
Note: See price list for information on ordering push pull sets.

*To specify multi-bar sets suffix -2 or -3 to pull number (example: RM3512-3).

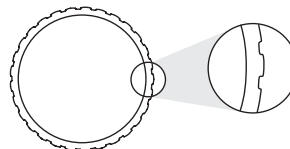

Tube Detail

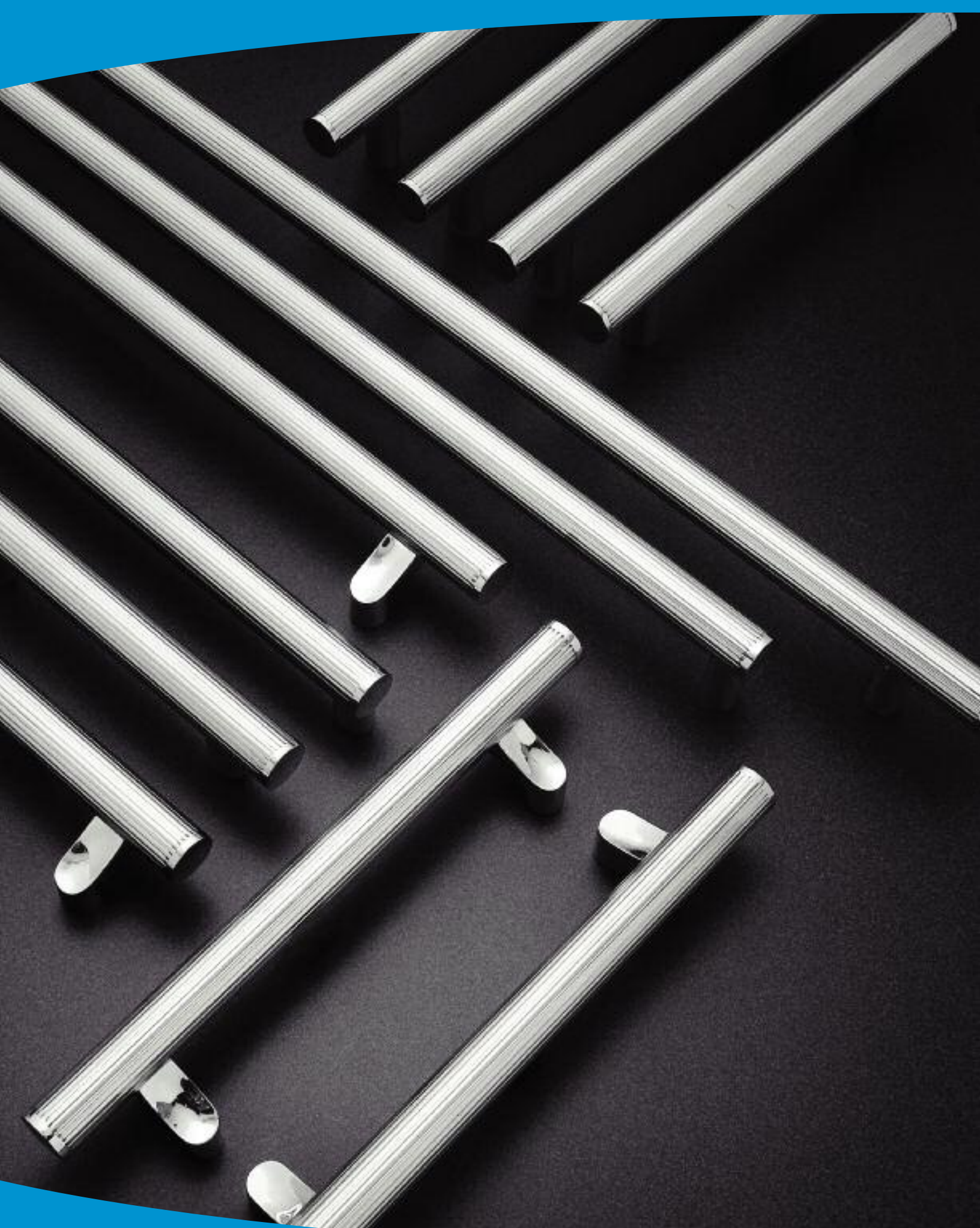

LineaTek pulls feature grooved tubular material that differentiates these pulls from all others on the market. The material is similar to fluted tubing but with a streamlined defined surface. These post mount pulls and push bars make a smart contemporary statement.

LineaTek™
fully grooved pulls

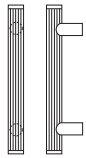

Straight Pulls - Square Ends

Pull No.	Diameter	CTC
RM3610	1¼"	8", 11", 16"
RM3620	1½"	11", 16", 20"

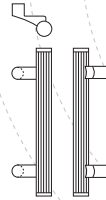

Offset Pulls - Square Ends

Pull No.	Diameter	CTC
RM3640	1¼"	8", 11", 16"
RM3650	1½"	11", 16", 20"

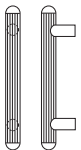

Straight Pulls - Round Ends

Pull No.	Diameter	CTC
RM3614	1¼"	8", 11", 16"
RM3624	1½"	11", 16", 20"

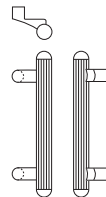

Offset Pulls - Round Ends

Pull No.	Diameter	CTC
RM3644	1¼"	8", 11", 16"
RM3654	1½"	11", 16", 20"

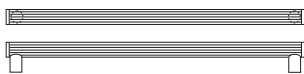

Push Bars - Square Ends*

Pull No.	Diameter	CTC
RM3612	1¼"	Specify
RM3622	1½"	Specify

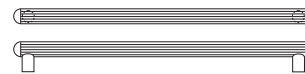

Push Bars - Round Ends*

Pull No.	Diameter	CTC
RM3616	1¼"	Specify
RM3626	1½"	Specify

Base Metals: Brass, bronze, stainless steel
Note: See price list for information on ordering push pull sets.

*To specify multi-bar sets suffix -2 or -3 to pull number (example: RM3612-2).

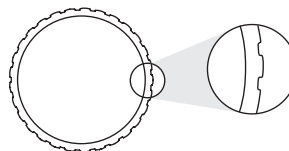

Tube Detail

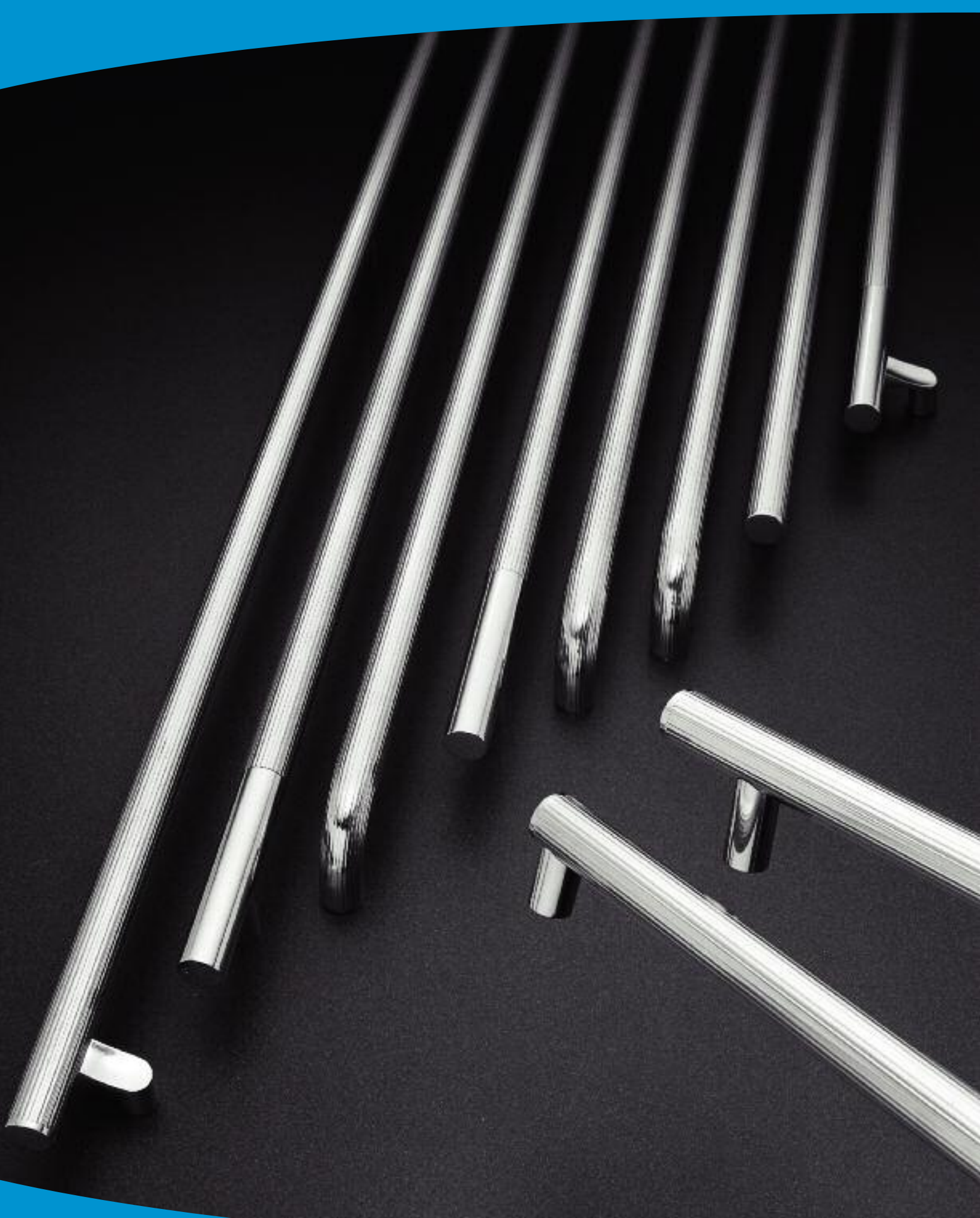

The crisp appearance of LineaMax creates a beautiful long door pull. Two post mounted styles — one with solid smooth ends and the other fully grooved are available in both straight and offset versions with any length required.

LineaMax™
long grooved pulls

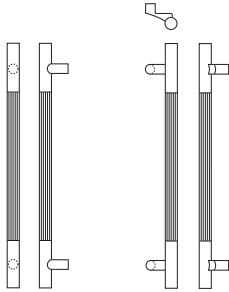

Straight Pulls - Square Ends

Pull No.	Diameter	CTC
RM3701	1½"	36" to 96"
RM3702	1½"	36" to 96"

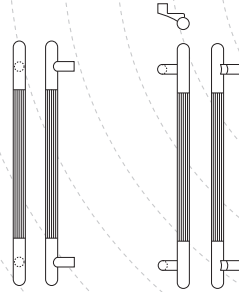

Straight Pulls - Round Ends

Pull No.	Diameter	CTC
RM3751	1½"	36" to 96"
RM3752	1½"	36" to 96"

Offset Pulls - Square Ends

Pull No.	Diameter	CTC
RM3711	1½"	36" to 96"
RM3712	1½"	36" to 96"

Offset Pulls - Round Ends

Pull No.	Diameter	CTC
RM3761	1½"	36" to 96"
RM3762	1½"	36" to 96"

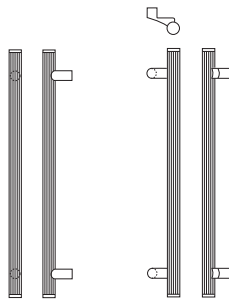

Straight Pulls - Square Ends

Pull No.	Diameter	CTC
RM3721	1½"	36" to 96"
RM3722	1½"	36" to 96"

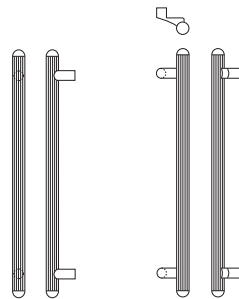

Straight Pulls - Round Ends

Pull No.	Diameter	CTC
RM3771	1½"	36" to 96"
RM3772	1½"	36" to 96"

Offset Pulls - Square Ends

Pull No.	Diameter	CTC
RM3731	1½"	36" to 96"
RM3732	1½"	36" to 96"

Offset Pulls - Round Ends

Pull No.	Diameter	CTC
RM3781	1½"	36" to 96"
RM3782	1½"	36" to 96"

Application Suggestions

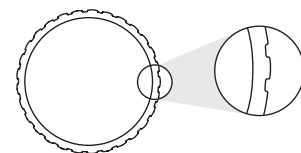
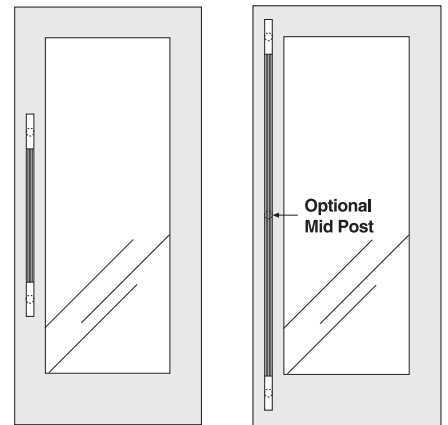

Tube Detail

Base Metal: Brass, bronze, stainless steel

Options: • For optional mid-post, suffix the product number with "MP" (example: RM3721MP).
• Over 96" available on select finishes.



The becoming subtle luster of the satin black hard coat anodized aluminum grip forms a striking contrast to the selected finish of the end sections. We show mirror polished stainless steel, but many alternative finishes are available. This compelling design is also practical due to its durability and high visibility. Available in three diameters and a variety of lengths.

NoirMet™
black anodized grip



Straight Pulls - Square Ends

Pull No.	Diameter	CTC
RM3800	1"	8", 10", 12"
RM3810	1¼"	8", 11", 16"
RM3820	1½"	11", 16", 20"

Up to 36" CTC available.

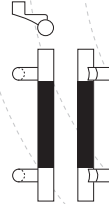

Offset Pulls - Square Ends

Pull No.	Diameter	CTC
RM3830	1"	8", 10", 12"
RM3840	1¼"	8", 11", 16"
RM3850	1½"	11", 16", 20"

Up to 36" CTC available.



Straight Pulls - Round Ends

Pull No.	Diameter	CTC
RM3804	1"	8", 10", 12"
RM3814	1¼"	8", 11", 16"
RM3824	1½"	11", 16", 20"

Up to 36" CTC available.

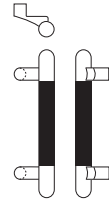

Offset Pulls - Round Ends

Pull No.	Diameter	CTC
RM3834	1"	8", 10", 12"
RM3844	1¼"	8", 11", 16"
RM3854	1½"	11", 16", 20"

Up to 36" CTC available.



Push Bars - Square Ends*

Pull No.	Diameter	CTC
RM3802	1"	Specify
RM3812	1¼"	Specify
RM3822	1½"	Specify



Push Bars - Round Ends*

Pull No.	Diameter	CTC
RM3806	1"	Specify
RM3816	1¼"	Specify
RM3826	1½"	Specify



Base Metals: Aluminum, brass, bronze, stainless steel
Note: See price list for information on ordering push pull sets.

*To specify multi-bar sets suffix -2 or -3 to pull number (example: RM3802-2).



NoirTek pulls stand out on light colored entrances for a quick identity and bold statement. The durable black hard coat anodized grips compliment many design schemes and are an appealing finish on their own. Choose from an array of contrasting finishes for the mounting posts. Available in three diameters and a variety of lengths.

NoirTek™
black anodized grip



Straight Pulls - Square Ends

Pull No.	Diameter	CTC
RM3900	1"	8", 10", 12"
RM3910	1¼"	8", 11", 16"
RM3920	1½"	11", 16", 20"

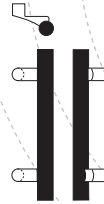

Offset Pulls - Square Ends

Pull No.	Diameter	CTC
RM3930	1"	8", 10", 12"
RM3940	1¼"	8", 11", 16"
RM3950	1½"	11", 16", 20"



Straight Pulls - Round Ends

Pull No.	Diameter	CTC
RM3904	1"	8", 10", 12"
RM3914	1¼"	8", 11", 16"
RM3924	1½"	11", 16", 20"

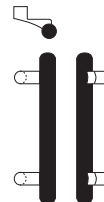

Offset Pulls - Round Ends

Pull No.	Diameter	CTC
RM3934	1"	8", 10", 12"
RM3944	1¼"	8", 11", 16"
RM3954	1½"	11", 16", 20"



Push Bars - Square Ends*

Pull No.	Diameter	CTC
RM3902	1"	Specify
RM3912	1¼"	Specify
RM3922	1½"	Specify



Push Bars - Round Ends*

Pull No.	Diameter	CTC
RM3906	1"	Specify
RM3916	1¼"	Specify
RM3926	1½"	Specify



Base Metals (for Posts): Brass, bronze, stainless steel
Note: See price list for information on ordering push pull sets.

*To specify multi-bar sets suffix -2 or -3 to pull number (example: RM3902-2).



The ArborMet group combines the alluring warmth of wood with the unrivaled strength of solid brass and stainless steel. The exceptionally sturdy wood grip consists of select dyed hardwood veneers impregnated with resin and laminated to produce a strong wood element. The gripping surface actually feels warmer to the touch than metal based pulls. A variety of natural wood species is available on special order; please contact the factory with your requirement.

ArborMet™
wood grip pulls

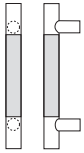

Straight Pulls - Square Ends

Pull No.	Diameter	CTC
RM4000	1"	8", 10", 12"
RM4010	1½"	8", 11", 16"
RM4020	1½"	11", 16", 20"

Up to 96" CTC available with mid-post.

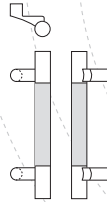

Offset Pulls - Square Ends

Pull No.	Diameter	CTC
RM4030	1"	8", 10", 12"
RM4040	1½"	8", 11", 16"
RM4050	1½"	11", 16", 20"

Up to 96" CTC available with mid-post.

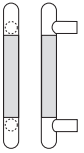

Straight Pulls - Round Ends

Pull No.	Diameter	CTC
RM4004	1"	8", 10", 12"
RM4014	1½"	8", 11", 16"
RM4024	1½"	11", 16", 20"

Up to 96" CTC available with mid-post.

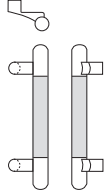

Offset Pulls - Round Ends

Pull No.	Diameter	CTC
RM4034	1"	8", 10", 12"
RM4044	1½"	8", 11", 16"
RM4054	1½"	11", 16", 20"

Up to 96" CTC available with mid-post.

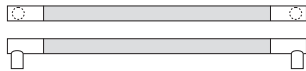

Push Bars - Square Ends*

Pull No.	Diameter	CTC
RM4002	1"	Specify
RM4012	1½"	Specify
RM4022	1½"	Specify



Push Bars - Round Ends*

Pull No.	Diameter	CTC
RM4006	1"	Specify
RM4016	1½"	Specify
RM4026	1½"	Specify

Application Suggestions

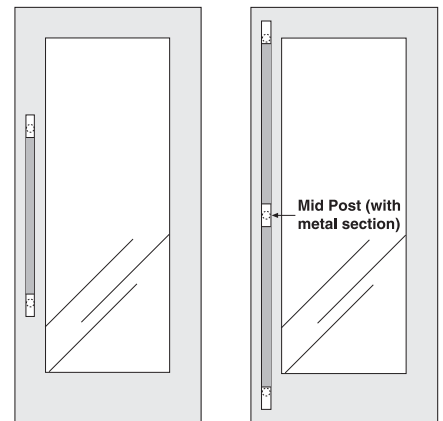

Base Metals: Brass, bronze, stainless steel
Options: Over 96" available on select finishes.
Note: See price list for information on ordering push pull sets.

*To specify multi-bar sets suffix -2 or -3 to pull number (example: RM4012-3).



ArborTek pulls and push bars are made from select dyed hardwood veneers that are impregnated with resin and laminated to produce a rugged wood element. Just as in nature, each has its unique markings and tone. Solid brass and stainless steel mounting posts provide attachment strength and a simple contrast. Available in three diameters. A variety of natural wood species is available on special order; please contact the factory with your requirement.

ArborTek™
wood grip pulls

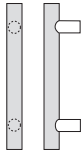

Straight Pulls - Square Ends

Pull No.	Diameter	CTC
RM4100	1"	8", 10", 12"
RM4110	1½"	8", 11", 16"
RM4120	1½"	11", 16", 20"

Up to 48" overall available.

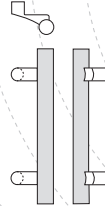

Offset Pulls - Square Ends

Pull No.	Diameter	CTC
RM4130	1"	8", 10", 12"
RM4140	1½"	8", 11", 16"
RM4150	1½"	11", 16", 20"

Up to 48" overall available.

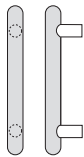

Straight Pulls - Round Ends

Pull No.	Diameter	CTC
RM4104	1"	8", 10", 12"
RM4114	1½"	8", 11", 16"
RM4124	1½"	11", 16", 20"

Up to 48" overall available.

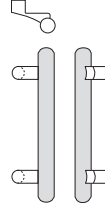

Offset Pulls - Round Ends

Pull No.	Diameter	CTC
RM4134	1"	8", 10", 12"
RM4144	1½"	8", 11", 16"
RM4154	1½"	11", 16", 20"

Up to 48" overall available.

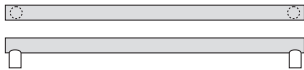

Push Bars - Square Ends*

Pull No.	Diameter	CTC
RM4112	1½"	Specify
RM4122	1½"	Specify

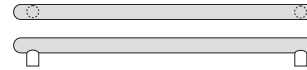

Push Bars - Round Ends*

Pull No.	Diameter	CTC
RM4116	1½"	Specify
RM4126	1½"	Specify

Base Metals: Brass, bronze, stainless steel
Note: See price list for information on ordering push pull sets.

*To specify multi-bar sets suffix -2 or -3 to pull number (example: RM4122-2).



The SoftMet pulls feature durable weather resistant black 1¼" diameter Santoprene™ grips sandwiched between metal fittings. Santoprene™ is a high performance engineered thermoplastic elastomer used for many consumer goods grip applications. The comfortable feel of this material is widely proven; even on cold exterior applications. Straight and offset pulls as well as push bars are available in all architectural finishes.

SoftMet™
with Santoprene™ grip



Straight Pull - Square End

Pull No.	Diameter	CTC
RM2510	1¼"	8", 11", 16"

Up to 36" CTC available.

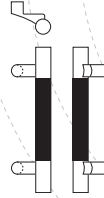

Offset Pull - Square End

Pull No.	Diameter	CTC
RM2540	1¼"	8", 11", 16"

Up to 36" CTC available.



Straight Pull - Round End

Pull No.	Diameter	CTC
RM2514	1¼"	8", 11", 16"

Up to 36" CTC available.

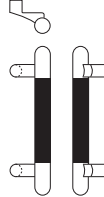

Offset Pull - Round End

Pull No.	Diameter	CTC
RM2544	1¼"	8", 11", 16"

Up to 36" CTC available.



Push Bar - Square End*

Pull No.	Diameter	CTC
RM2512	1¼"	Specify



Push Bar - Round End*

Pull No.	Diameter	CTC
RM2516	1¼"	Specify

Base Metals: Brass, bronze, stainless steel

© 2006 Rockwood Manufacturing Company

*To specify multi-bar sets suffix -2 or -3 to pull number (example: RM2512-2).

Santoprene™ is a trademark of Santoprene™ Specialty Products

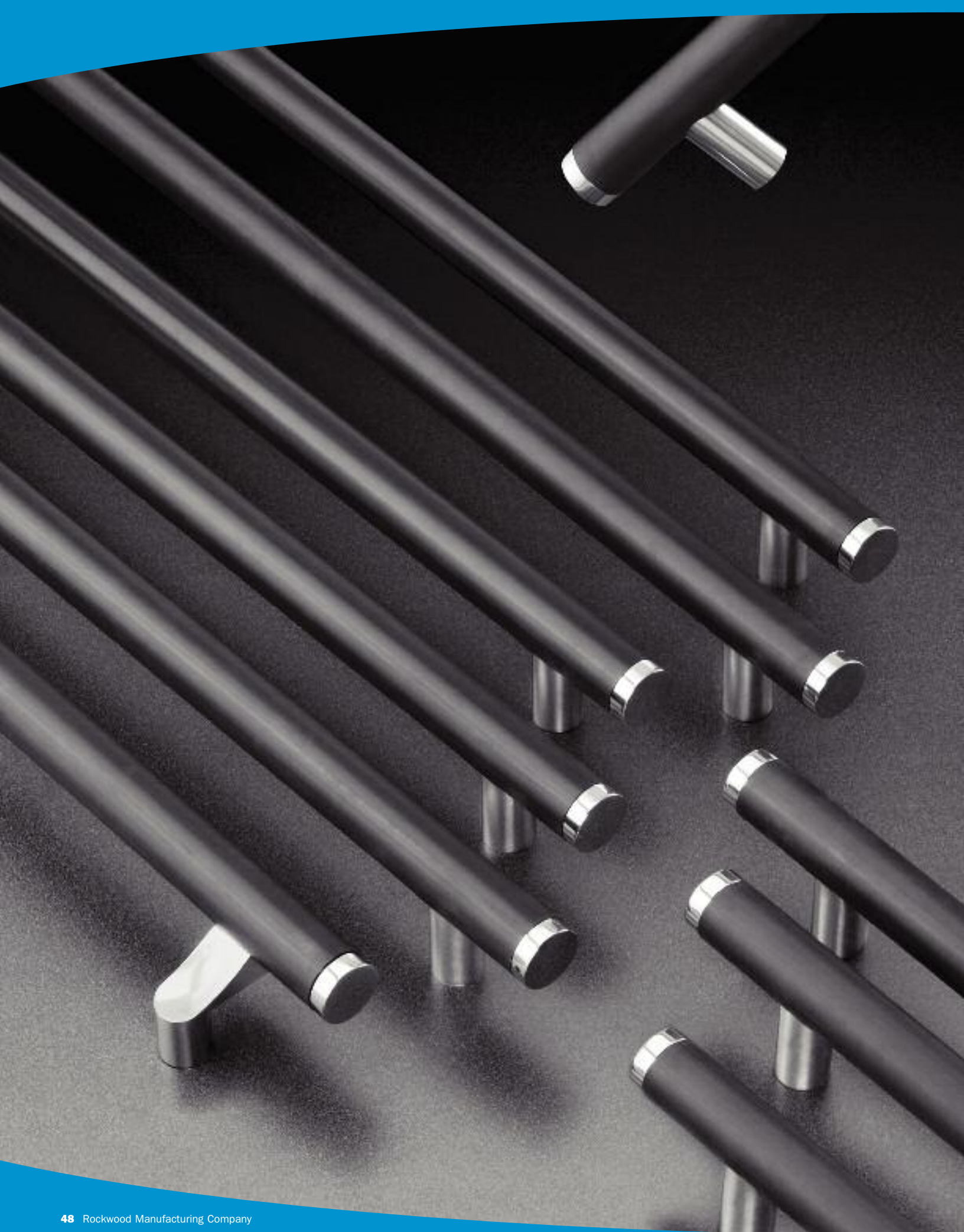

The SoftTek pulls feature a durable weather resistant black 1¼" diameter Santoprene™ grip that provides a soft, warm feeling gripping surface. They are suitable for both interior and exterior applications. These grips are comfortable to touch even in cold temperature extremes. Available in straight and offset pulls and push bars in all architectural finishes.

SoftTek™
with Santoprene™ grip



Straight Pull

Pull No.	Diameter	CTC
RM2610	1¼"	8", 11", 16"

Up to 36" CTC available.



Offset Pull

Pull No.	Diameter	CTC
RM2640	1¼"	8", 11", 16"

Up to 36" CTC available.



Push Bar*

Pull No.	Diameter	CTC
RM2612	1¼"	Specify

Application Suggestions

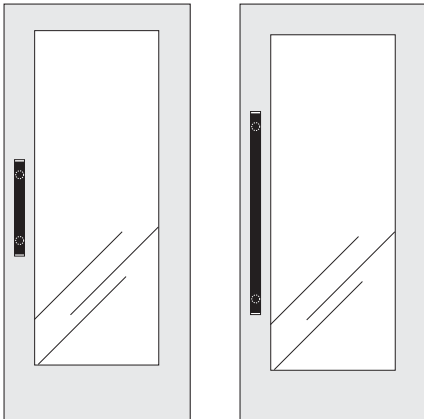

Base Metals: Brass, bronze, stainless steel

© 2006 Rockwood Manufacturing Company

*To specify multi-bar sets suffix -2 or -3 to pull number (example: RM2612-2).



Cork is a renewable resource harvested on farms in the Iberian Peninsula. Its unique qualities arise from a structure of air filled watertight flexible cells, which make it a superior insulating medium. Therefore, IberMet pulls are ideal for use in high and low temperature locations. Our natural cork is aesthetically attractive, preserved with a sealer to maintain its surface finish. We also offer a rubber cork compound featuring an attractive and very durable composite cork grip.

IberMet™
with cork grips



Straight Pulls - Square Ends

Pull No.	Cork	Diameter	CTC
RM2710N	Natural	1½"	8", 11", 16"
RM2710R	Rubber Compound	1½"	8", 11", 16"

Up to 22" CTC available.

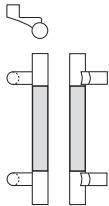

Offset Pulls - Square Ends

Pull No.	Cork	Diameter	CTC
RM2740N	Natural	1½"	8", 11", 16"
RM2740R	Rubber Compound	1½"	8", 11", 16"

Up to 22" CTC available.

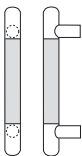

Straight Pulls - Round Ends

Pull No.	Cork	Diameter	CTC
RM2714N	Natural	1½"	8", 11", 16"
RM2714R	Rubber Compound	1½"	8", 11", 16"

Up to 22" CTC available.

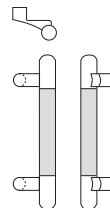

Offset Pulls - Round Ends

Pull No.	Cork	Diameter	CTC
RM2744N	Natural	1½"	8", 11", 16"
RM2744R	Rubber Compound	1½"	8", 11", 16"

Up to 22" CTC available.



Natural Cork



Rubber Compound

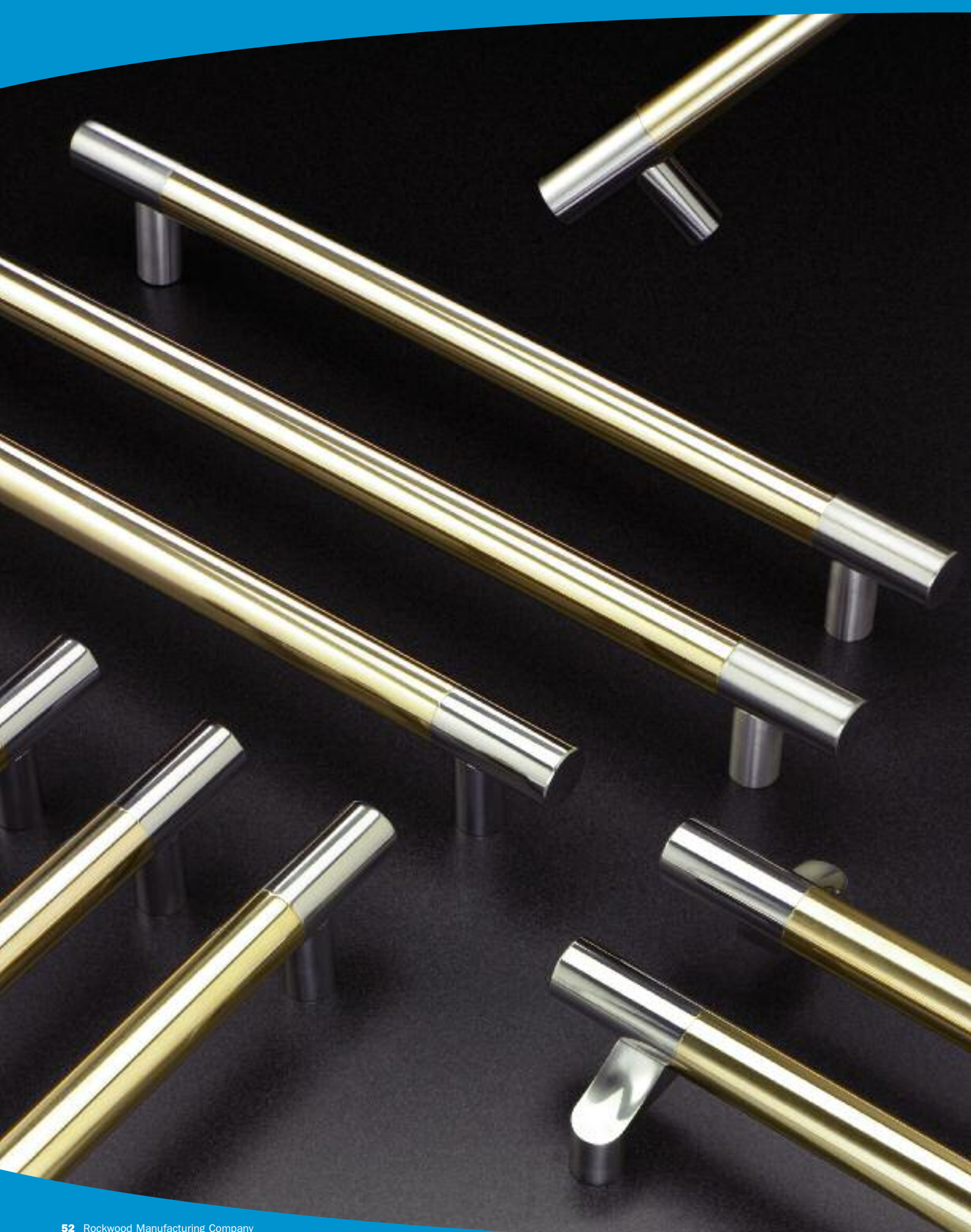

The BronzeAge pulls are composed of a 90% copper alloy uncoated grip section with stainless steel ends and mounting posts. This combination provides the beautiful effects of copper with the low maintenance of stainless steel. Repeated contact with the grip section will prevent extreme tarnishing and allow a soft patina to develop while the ends and mounting posts stay bright and shiny with little maintenance. Clear coating is available if natural patina is not desired.

BronzeAge™
with copper rich grip

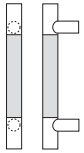

Straight Pulls - Square Ends

Pull No.	Diameter	CTC
RM2810	1½"	8", 11", 16"
RM2820	1½"	11", 16", 20"

Up to 36" CTC available.

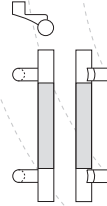

Offset Pulls - Square Ends

Pull No.	Diameter	CTC
RM2840	1½"	8", 11", 16"
RM2850	1½"	11", 16", 20"

Up to 36" CTC available.

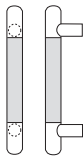

Straight Pulls - Round Ends

Pull No.	Diameter	CTC
RM2814	1½"	8", 11", 16"
RM2824	1½"	11", 16", 20"

Up to 36" CTC available.

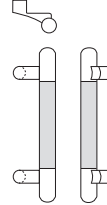

Offset Pulls - Round Ends

Pull No.	Diameter	CTC
RM2844	1½"	8", 11", 16"
RM2854	1½"	11", 16", 20"

Up to 36" CTC available.

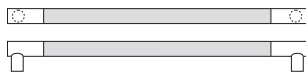

Push Bars - Square Ends*

Pull No.	Diameter	CTC
RM2812	1½"	Specify
RM2822	1½"	Specify

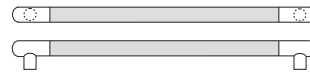

Push Bars - Round Ends*

Pull No.	Diameter	CTC
RM2816	1½"	Specify
RM2826	1½"	Specify

Base Metals: Stainless steel, bronze (brass available).

Options: For optional clear coated grip, suffix the product number with "L" (example: RM2812L).

*To specify multi-bar sets suffix -2 or -3 to pull number (example: RM2812-3).

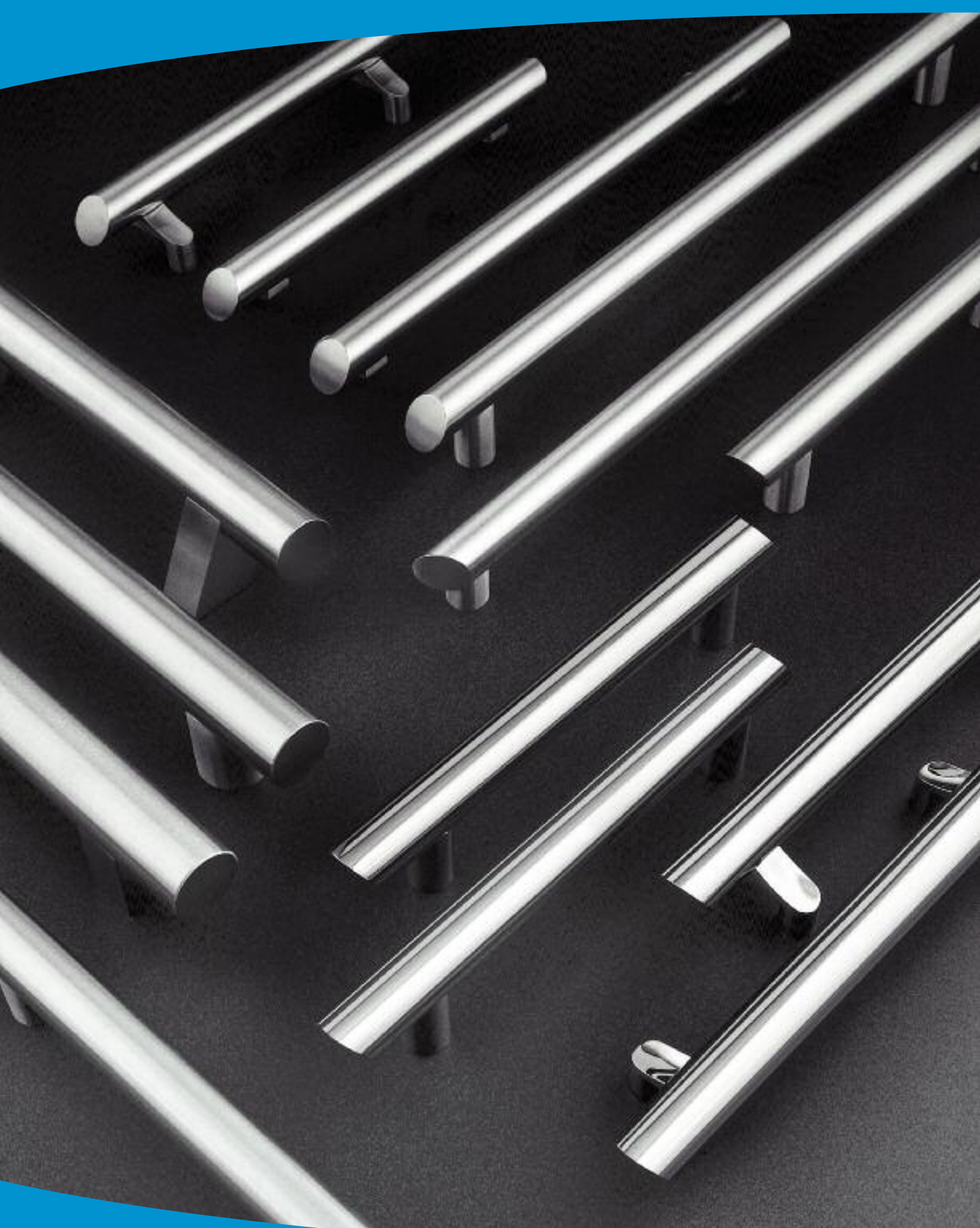

Thirty-degree end cuts on 1½" diameter tubular pulls generate an interesting design element that distinguishes these pulls from the ordinary. We formulate many modifications to these basic designs. Because these are made to order, we can accomplish variations to suit your particular whim. Larger 2" diameter pulls with square ends are perfect for extra large entrances.

SkewTek™

angled end pulls & big pulls



Straight Pull

Pull No.	Diameter	CTC
RM4200	1½"	11"

Up to 96" CTC available.

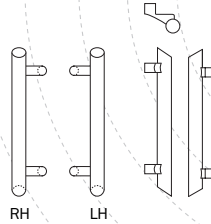

Offset Pulls

Pull No.	Diameter	CTC
RM4210LH*	1½"	11"
RM4210RH*	1½"	11"

Up to 96" CTC available.

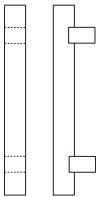

Straight Pulls - Rectangle Post

Pull No.	Diameter	CTC
RM4270-12	2"	12"
RM4270-24	2"	24"

Up to 96" CTC available.

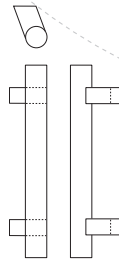

Offset Pulls - Rectangle Post

Pull No.	Diameter	CTC
RM4272-12	2"	12"
RM4272-24	2"	24"

Up to 96" CTC available.

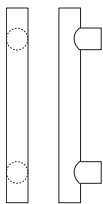

Straight Pulls - Round Post

Pull No.	Diameter	CTC
RM4274-12	2"	12"
RM4274-24	2"	24"

Up to 96" CTC available.

Application Suggestions

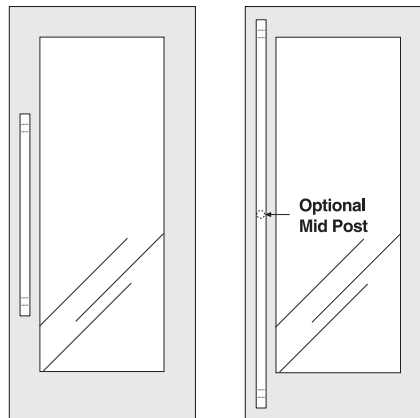

Base Metals: Aluminum, brass, bronze, stainless steel (select products - see price list for availability)

Options: Over 96" available on select finishes.

* Handing illustrated for PULL side of door



The CenTek Series is a collection of 1" diameter pulls for entry doors. The shapes create an attractive symmetry at an entrance and will work in conjunction with standard 1" diameter push bars. Custom center to center and diameters are available.

CenTek™
1" radius pulls



Pull No. **CTC**
RM4300 42"

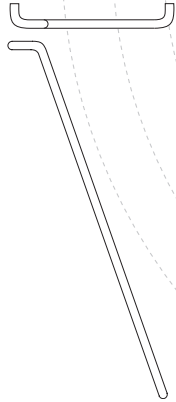

Pull No. **CTC**
RM4301 42"



Pull No. **CTC**
RM4302 42"

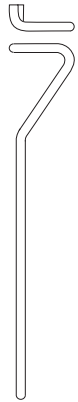

Pull No. **CTC**
RM4303 42"



Pull No. **CTC**
RM4304 42"



Pull No. **CTC**
RM4305 42"

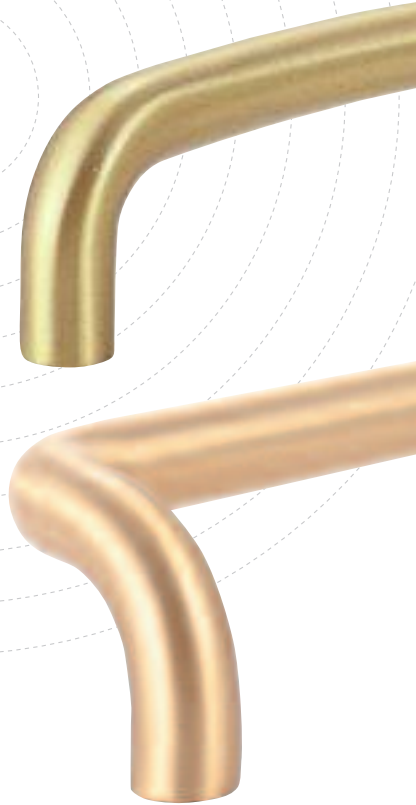

Base Metals: Aluminum, brass, bronze, stainless steel



CentTrex Door Pulls and Push Bars are gracefully curved 1" diameter solid rods that provide a subtly distinctive look to any door. The shapes are sleek and comfortable to grasp. Combine pulls with bars to make a unique set.

CentTrex™
1" radius pulls

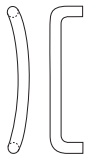

Curved Pulls

Pull No.	CTC
RM4400-12	12"
RM4400-20	20"

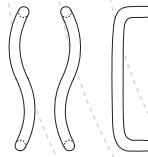

RH LH

Double Curved Pulls

Pull No.	CTC
RM4402LH*	12"
RM4402RH*	12"

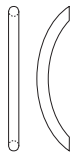

Straight Pull

Pull No.	CTC
RM4410	12", 18", 24"

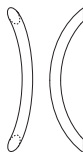

Offset Pull

Pull No.	CTC
RM4412	12", 18", 24"

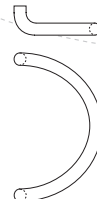

Semi-Circular Pulls

Pull No.	CTC
RM4420	9"
RM4422	12"

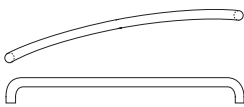

LH

Push Bar

Pull No.	CTC
RM4440LH**	Specify

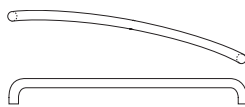

RH

Push Bar

Pull No.	CTC
RM4440RH**	Specify



LH

Push Bar

Pull No.	CTC
RM4450LH**	Specify

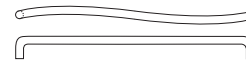

RH

Push Bar

Pull No.	CTC
RM4450RH**	Specify

Base Metals: Aluminum, brass, bronze, stainless steel

*Handing illustrated for PULL side of door.

**Handing illustrated for PUSH side of door.



These CentTrex Door Pulls and Push Bars are composed of sturdy 1¼" tubes, rods or heavy castings. The smooth expanse of metal in a pair of these circular shape pulls creates an inviting focal point to an entrance. Large radius pulls provide comfortable gripping. All pulls can be used in conjunction with push bars from this or other groups. Specify the pull number x the push bar number.

CentTrex™
large radius pulls

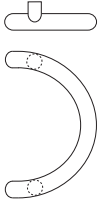

Semi-Circular Pull

Pull No.	CTC
RM4500	11"



Semi-Circular Pull

Pull No.	CTC
RM4502	11"



Semi-Circular Pull

Pull No.	CTC
RM4506	12"

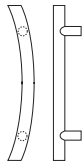

Offset Pull

Pull No.	CTC
RM4510	12"



Straight Pull

Pull No.	CTC
RM4512	12"

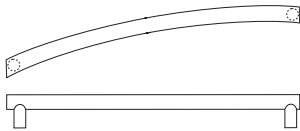

Push Bar

Pull No.	CTC
RM4516LH*	Specify

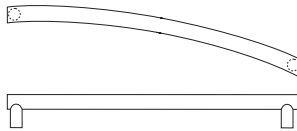

Push Bar

Pull No.	CTC
RM4516RH*	Specify

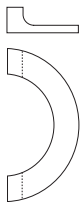

Semi-Circular Pull

Pull No.	CTC
RM4550	12"

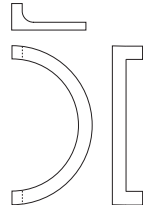

Semi-Circular Pull

Pull No.	CTC
RM4552	14"

Base Metals: Aluminum, brass, bronze, stainless steel (select products - see price list for availability)

*Handing illustrated for PULL side of door.

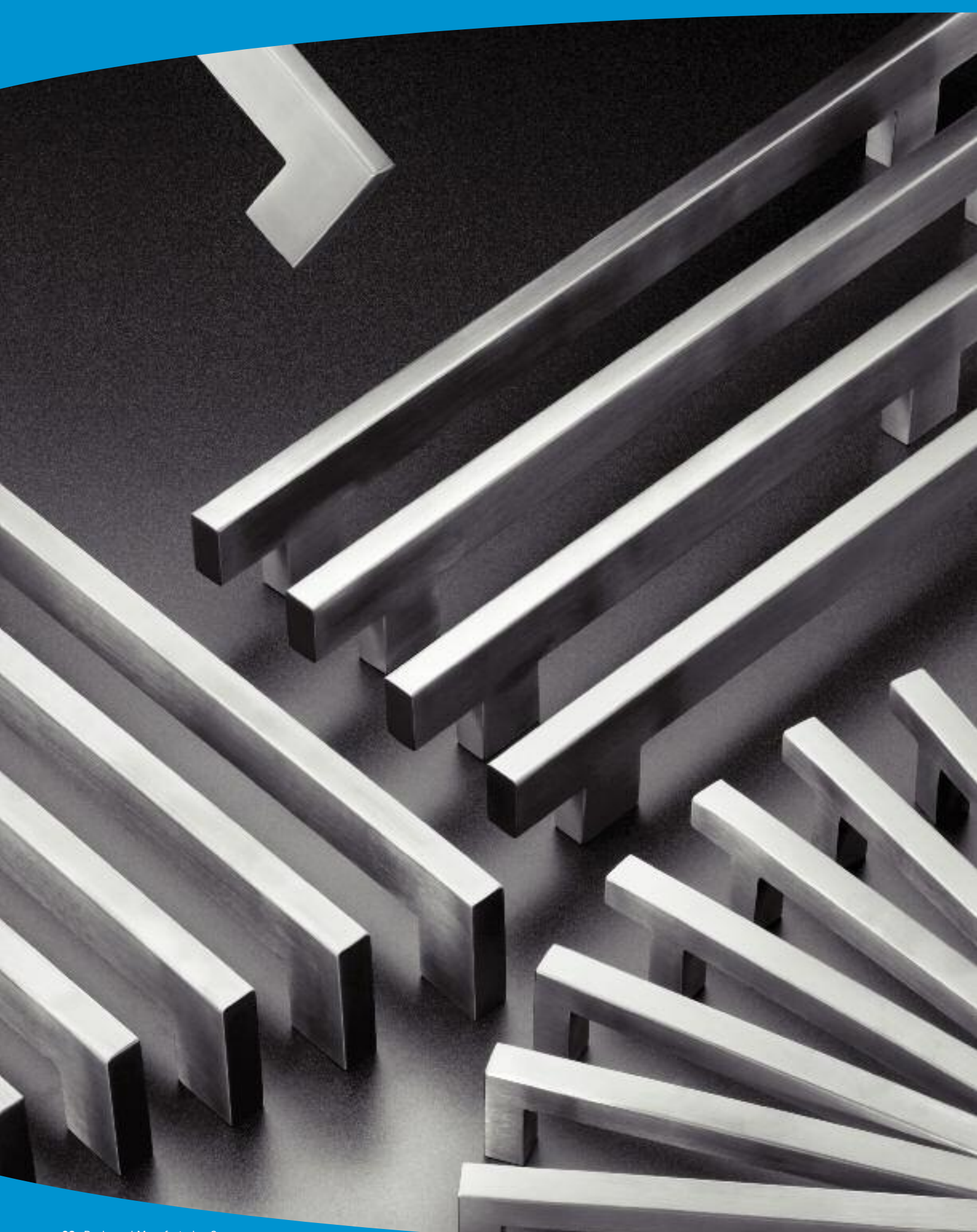

These tubular square and rectangular pulls offer a narrow profile and clean lines. Two shapes in two designs allow one to scale a pull to any size opening. Custom sizes available.

GeoMetek™
narrow profile pulls



Square End Pull

Pull No.	Material	CTC
RM7900	¾" x ¾"	6", 8", 11", 16"

Up to 48" CTC available.



Square Bridge Pull

Pull No.	Material	CTC
RM7902	¾" x ¾"	6", 8", 11", 16"

Up to 48" CTC available.

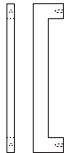

Rectangular End Pull

Pull No.	Material	CTC
RM7910	¾" x 1½"	11", 16", 20"

Up to 96" CTC available.

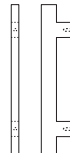

Rectangular Bridge Pull

Pull No.	Material	CTC
RM7912	¾" x 1½"	11", 16", 20"

Up to 96" CTC available.

Application Suggestions

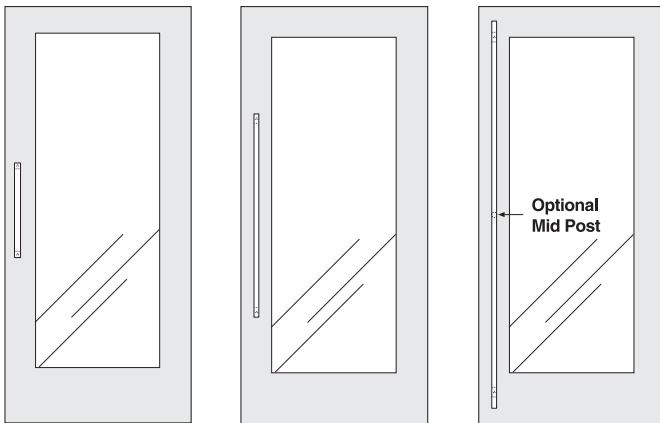

Base Metal: Stainless steel

Options: • For optional mid-post, suffix the product number with MP" (example: RM7910MP).
• Over 96" available on select finishes.



The PlanTek group consists of pulls made from a range of sizes of flat and rectangular bar stock or castings. The cast pulls feature a contour area underneath the grip for a comfortable ergonomic feel. Pulls made from bar stock are available in any length to order. A large variety of bar, rod, and tubing sizes are stocked so alternative designs may be readily made.

PlanTek™
flat front pulls

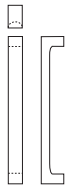
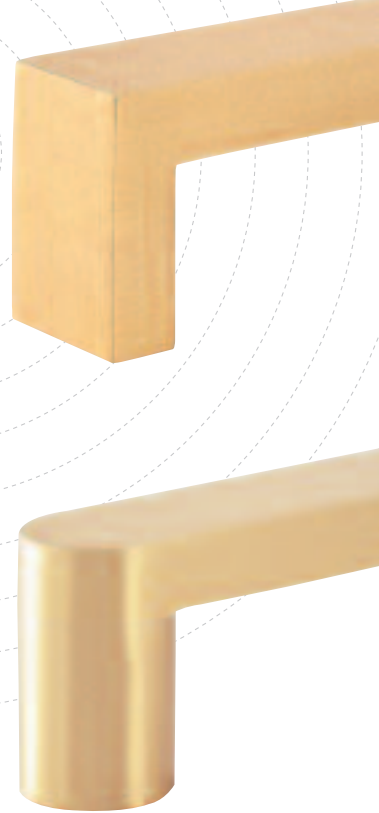

Straight Cast Pulls

Pull No.	CTC	Width
RM5200-7	7"	1"
RM5200-12	12"	1"
RM5202	12"	1½"

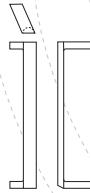

Offset Cast Pulls

Pull No.	CTC	Width
RM5204-8	8"	1"
RM5204-12	12"	1"



Radius End Pulls

Pull No.	Material	CTC
RM5210-10	½" x 1¼"	10"
RM5210-12	½" x 1¼"	12"
RM5220-12	¾" x 1½"	12"
RM5220-18	¾" x 1½"	18"

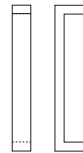

Square End Pulls

Pull No.	Material	CTC
RM5230-10	½" x 1¼"	10"
RM5230-12	½" x 1¼"	12"
RM5240-12	¾" x 1½"	12"
RM5240-18	¾" x 1½"	18"

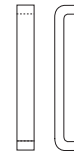

Bent End Pulls

Pull No.	Material	CTC
RM5250-10	½" x 1¼"	10"
RM5250-12	½" x 1¼"	12"
RM5260-12	¾" x 1½"	12"
RM5260-18	¾" x 1½"	18"



Straight Cast Pull

Pull No.	Material	CTC
RM5280	½" x ½"	9"

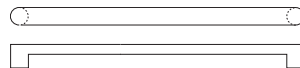

Radius End Push Bars

Pull No.	Material	CTC
RM5212	½" x 1¼"	Specify
RM5222	¾" x 1½"	Specify

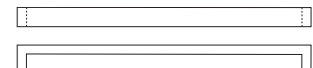

Square End Push Bars

Pull No.	Material	CTC
RM5232	½" x 1¼"	Specify
RM5242	¾" x 1½"	Specify

Base Metals: Brass, bronze, stainless steel (select products - see price list for availability)



Convey a sense of sophisticated quality with a SculpTrex pull.
 The group consists of flowing designs in cast brass and bronze.
 The inviting shapes are as comfortable to the hand as they are
 appealing to the eye. A variety of finishes are available.

SculpTrex™
shaped cast pulls

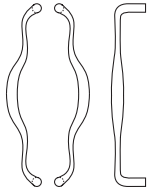

Pull No.	CTC
RM5000	12"

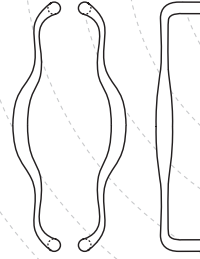

Pull No.	CTC
RM5002	20"

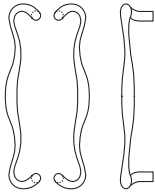

Pull No.	CTC
RM5010	12"

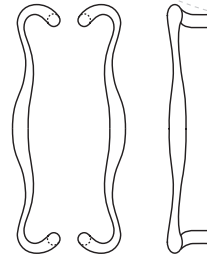

Pull No.	CTC
RM5012	20"

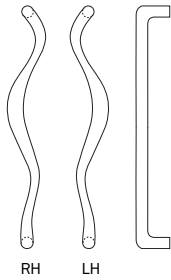

Pull No.	CTC
RM5020LH*	20"
RM5020RH*	20"



Base Metal: Brass, bronze, white bronze

*Handing illustrated for PULL side of door.



The SculpTrex group includes these graceful curved designs that feel as good as they look. Cast in brass and bronze, they are available in a variety of finishes. Please refer to the price list for further details.

SculpTrex™
shaped cast pulls



Pull No. **CTC**
RM5030 12"

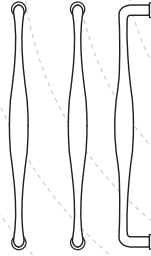

Pull No. **CTC**
RM5032 20"

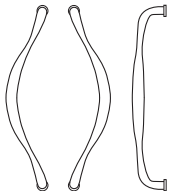

Pull No. **CTC**
RM5040 12"

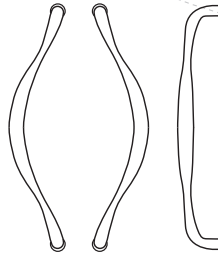

Pull No. **CTC**
RM5042 20"

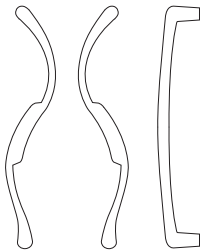

RH LH

Pull No. **CTC**
RM5050LH* 20"
RM5050RH* 20"

Base Metal: Brass, bronze, white bronze

*Handing illustrated for PULL side of door.



These striking designs are distinctive in their all metal version. Base metals of brass and bronze provide a variety of finishes. Use either symmetrical or asymmetrical pairs on a pair of doors as illustrated when you want to denote an entrance of prominence.

InfiniTriX™
shaped cast pulls

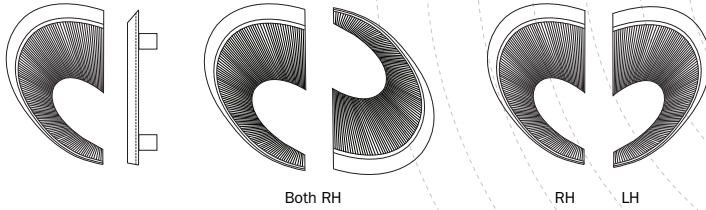

Solid Cast

Pull No.	CTC
RM5100LH*	10"
RM5100RH*	10"

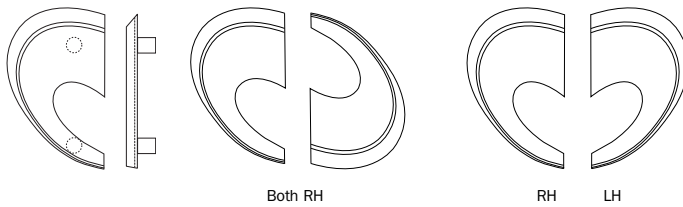

Roseate Granite Inlay

Pull No.	CTC
RM5110LH*	10"
RM5110RH*	10"

DISCONTINUED 12/09

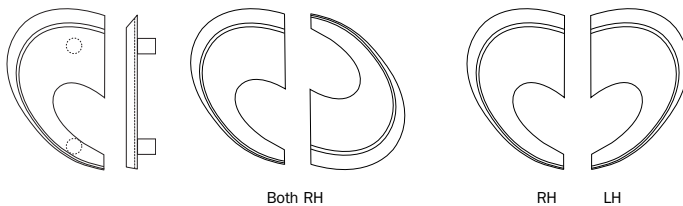

Ebony Granite Inlay

Pull No.	CTC
RM5112LH*	10"
RM5112RH*	10"

DISCONTINUED 12/09

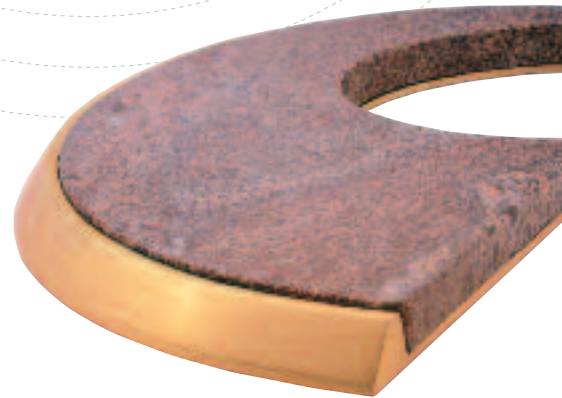
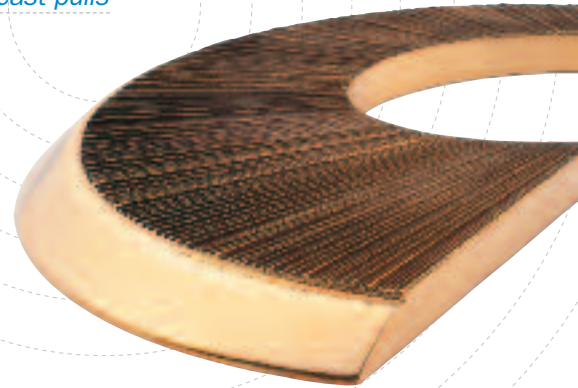

Base Metal: Brass, bronze, white bronze

*Handing illustrated for PULL side of door.

REVISED 12/09



These are cast pulls and thick metal push plates — traditional style pulls and plates, but made to commercial quality standards. Heavy gauge material and high quality castings are the basis for this group. Choose from a variety of finishes shown in our price list.

Traditional

decorative pulls & plates

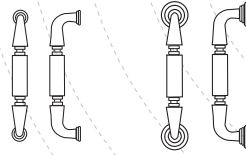
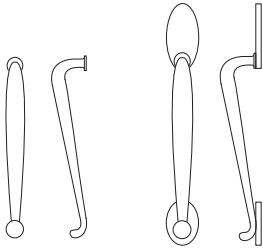
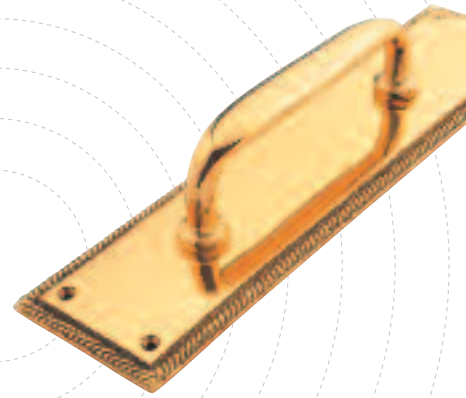

Cast Pulls

Pull No.	Base Plate	CTC
RM5500	No	6"
RM5502	Yes	6 7/8"
RM5510	No	12"
RM5512	Yes	12 1/2"

Cast Pulls

Pull No.	Base Plate	CTC
RM5520	No	8"
RM5522	Yes	8"



Many finishes available



Cast Pulls

Pull No.	CTC
RM5530	5 1/2"
RM5532	7 1/2"
RM5534	12"

Rope Border Cast Plates

Plate No.	Size
RM5596A	3" x 12"
RM5596B	3 1/2" x 15"

Plain Cast Plate - 1/16" Thick

Plate No.	Size
RM5598B	3 1/2" x 15"

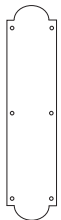

Heavy Plates - .090" Thick

Plate No.	Size
RM5590A	3" x 12"
RM5590B	3 1/2" x 15"
RM5590C	4" x 16"

Heavy Plates - .090" Thick

Plate No.	Size
RM5592A	3" x 12"
RM5592B	3 1/2" x 15"
RM5592C	4" x 16"

Heavy Plate - .090" Thick

Plate No.	Size
RM5594B	3 1/2" x 15"



Create a unique pull by combining any of the three grip styles with one of the four finial styles. Grips are available in 3/4" diameter with 6" center to center and 1" diameter with 10" center to center with appropriately sized finials in all designs. Standard lengths are shown, but custom lengths are readily available. Add base plates for an extra decorative feature. These traditional styles incorporate our commercial quality mounting systems that will endure heavy traffic.

Classic

finial door pulls

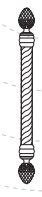
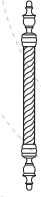
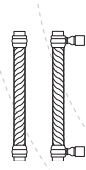
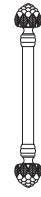
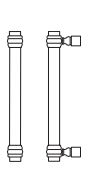
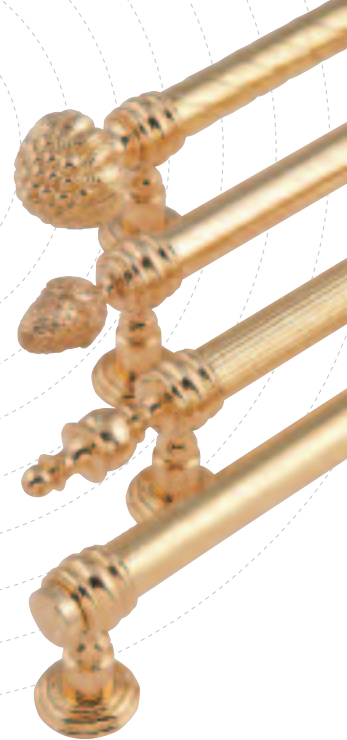

Plain Grip

Pull No.	Diameter	CTC	Base Plate
RM5600	3/4"	6"	No
RM5610	3/4"	6"	Yes
RM5650	1"	10"	No
RM5660	1"	10"	Yes

Up to 36" CTC available.

Rope Grip

Pull No.	Diameter	CTC	Base Plate
RM5602	3/4"	6"	No
RM5612	3/4"	6"	Yes
RM5652	1"	10"	No
RM5662	1"	10"	Yes

Up to 36" CTC available.

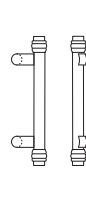
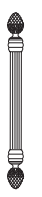
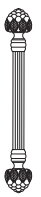
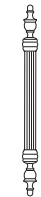
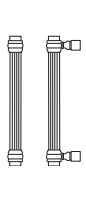

Fluted Grip

Pull No.	Diameter	CTC	Base Plate
RM5604	3/4"	6"	No
RM5614	3/4"	6"	Yes
RM5654	1"	10"	No
RM5664	1"	10"	Yes

Up to 36" CTC available.

Plain Offset

Pull No.	Diameter	CTC
RM5670	1"	10"

Up to 36" CTC available.



1

2

3

4

Finial Style Number (example: RM5650-4)

Suffix	Finial Style
1	Plain
2	Urn
3	Berry
4	Pinecone

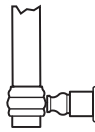
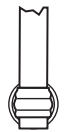

Optional Base Plate

Diameter
1 1/2"



Many finishes available

Specifying Information

1. Select style pull number
2. Suffix finial style number to pull number

Example: RM5660-2

These practical and attractive edge pulls are made to order in our factory. The simple seamless construction is available up to 6" long. Available in most architectural finishes.

Edge Pulls

for closet doors

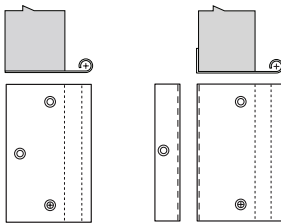

Edge Pulls - Square Edge Door

Pull No.	Return	Rod Size
RM751	No	7/16"
RM752	Yes	7/16"

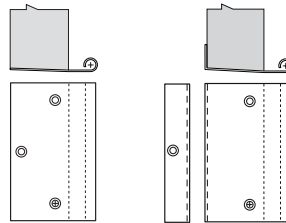

Edge Pulls - Bevel Edge Door

Pull No.	Return	Rod Size
RM753	No	7/16"
RM754	Yes	7/16"

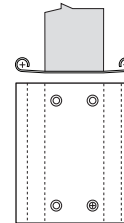

Double Edge Pull - Square Edge

Pull No.	Rod Size
RM755	7/16"



Concealed Edge Pull

Pull No.	Size
RM760	1" x 4 1/4"

Application Suggestion

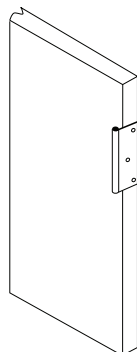

Specifying Information

1. Select style pull number
2. Select standard length: 2", 2 1/2", 3", 4", 5", 6"
3. Specify door thickness
4. Select standard architectural finish

Example: RM752-4" 1 3/4" door US32D

Base Metals: Brass, bronze, stainless steel
(RM750 series only)

Our small pulls are made from larger diameter rod than commonly available "wire" pulls. A range of finishes and sizes is available or made to order. Our cast flush pulls are an attractive solution where protruding pulls are not desired.

Small Pulls

for cabinets, casework and closet doors

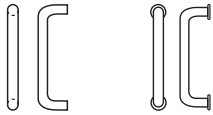
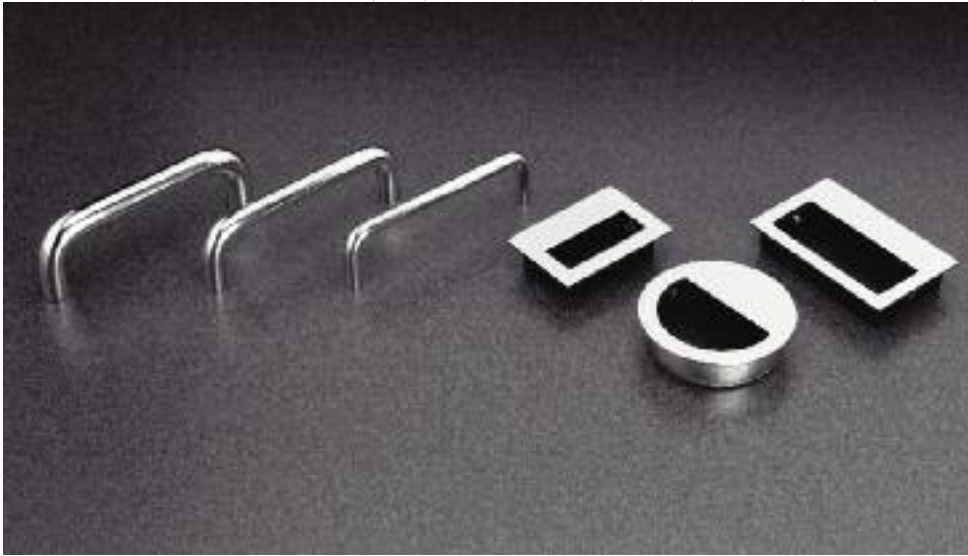

Closet Door Pulls

Pull No.	Diameter	CTC	Base Plate
RM710	3/8"	4", 5", 6"	No
RM715	3/8"	4", 5", 6"	Yes
RM720	1/2"	4", 5", 6"	No
RM725	1/2"	4", 5", 6"	Yes
RM730	3/8"	4", 5", 6"	No
RM735	3/8"	4", 5", 6"	Yes

Up to 18" CTC available.

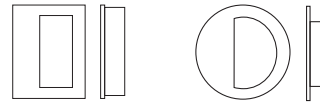

Flush Pulls

Pull No.	Size	Opening	Depth
RM780	2 3/8" x 3 1/4"	7/8" x 2 1/8"	3/4"
RM782	2 1/4" x 4 3/8"	1 1/8" x 3 1/2"	3/4"
RM785	3 1/2" dia.	2 3/8" x 1 1/8"	7/8"

Base Metals: Brass, stainless steel (select products - see price list for availability)

Closet Door Pull Mounting: 8-32 x 1 THMS (Standard drawer thickness is 3/4"; advise if other than 3/4")

Flush Pull Mounting: #8 x 3/4 OHSMS (Minimum door thickness is 1")

Straight and offset post mount pulls are available in most architectural finishes including stainless steel. Custom sizes are readily available. RM1200 and RM1300 Series are available with our inorganic BioGuard® antimicrobial finish US32DBIO. GripZone design is practical and attractive.

Small PostMount Pulls

for cabinets, casework and closet doors

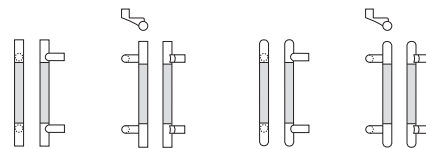
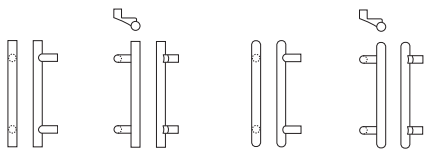

Small Pulls

Pull No.	Post	End	Diameter	CTC*
RM1200	Straight	Square	½"	4", 5", 6", 8", 10", 12"
RM1210	Straight	Square	⅝"	5", 6", 7", 8", 10", 12"
RM1230	Offset	Square	⅝"	5", 6", 7", 8", 10", 12"
RM1240	Straight	Round	½"	4", 5", 6", 8", 10", 12"
RM1250	Straight	Round	⅝"	5", 6", 7", 8", 10", 12"
RM1270	Offset	Round	⅝"	5", 6", 7", 8", 10", 12"

Small GripZone Pulls

Pull No.	Post	End	Diameter	CTC*
RM1300	Straight	Square	½"	4", 5", 6", 8", 10", 12"
RM1310	Straight	Square	⅝"	5", 6", 7", 8", 10", 12"
RM1330	Offset	Square	⅝"	5", 6", 7", 8", 10", 12"
RM1340	Straight	Round	½"	4", 5", 6", 8", 10", 12"
RM1350	Straight	Round	⅝"	5", 6", 7", 8", 10", 12"
RM1370	Offset	Round	⅝"	5", 6", 7", 8", 10", 12"

Base Materials: Brass, stainless steel

Mounting: 8-32 x 1 THMS (Standard drawer thickness is ¾"; advise if other than ¾")

Options: Long lengths with multiple posts available made to order.

* Any size to order

© 2006 Rockwood Manufacturing Company

Rockwood applies its full size pull design to these small pulls. The attractive features and textures make an interesting addition to the small pull range. Custom sizes and grips are available on special order.

Small PostMount Pulls

for cabinets, casework and closet doors

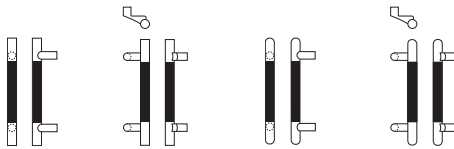

NoirMet Pulls (Black Aluminum Grip)

Pull No.	Post	End	Diameter	CTC
RM1410	Straight	Square	5/8"	5", 6"
RM1430	Offset	Square	5/8"	5", 6"
RM1450	Straight	Round	5/8"	5", 6"
RM1470	Offset	Round	5/8"	5", 6"

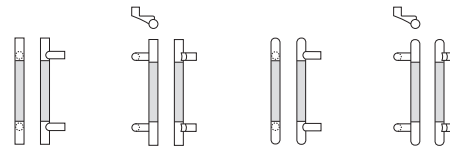

ArborMet Pulls (Wood Grip)

Pull No.	Post	End	Diameter	CTC
RM1510	Straight	Square	5/8"	5", 6"
RM1530	Offset	Square	5/8"	5", 6"
RM1550	Straight	Round	5/8"	5", 6"
RM1570	Offset	Round	5/8"	5", 6"

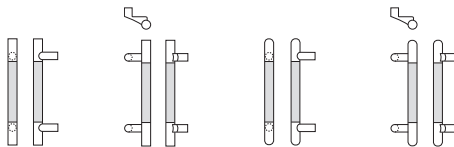

IberMet Pulls (Rubber Cork Compound Grip)

Pull No.	Post	End	Diameter	CTC
RM1610R	Straight	Square	5/8"	5", 6"
RM1630R	Offset	Square	5/8"	5", 6"
RM1650R	Straight	Round	5/8"	5", 6"
RM1670R	Offset	Round	5/8"	5", 6"

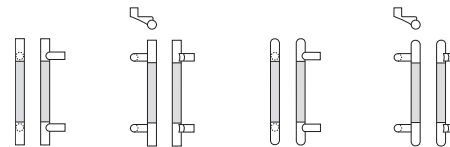

IberMet Pulls (Natural Cork Grip)

Pull No.	Post	End	Diameter	CTC
RM1610N	Straight	Square	5/8"	5", 6"
RM1630N	Offset	Square	5/8"	5", 6"
RM1650N	Straight	Round	5/8"	5", 6"
RM1670N	Offset	Round	5/8"	5", 6"

Base Metals: Brass, stainless steel

Mounting: 8-32 x 1 THMS (Standard drawer thickness is 3/4"; advise if other than 3/4")

Options: Custom sizes made to order.

© 2006 Rockwood Manufacturing Company

Coat Hooks

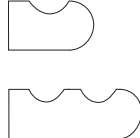
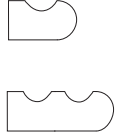
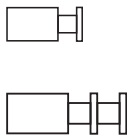
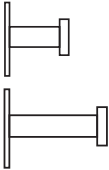

Coat Hooks

Hook No.	Size
RM801	1 1/4" x 1 3/4"
RM802	1 3/4" x 2 3/4"

Hook No.	Size
RM803	1" x 2"
RM804	1" x 3"

Hook No.	Size
RM805	1" x 1 3/4"
RM806	1" x 3"

Hook No.	Size
RM807	1 3/4" x 2 3/4"
RM808	1 3/4" x 3 1/2"

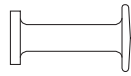
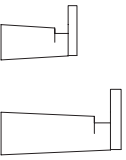

Hook No.	Size
RM809	1 3/8" x 1 1/8"
RM810	1 3/8" x 2 1/8"

Hook No.	Size
RM811	3/4" x 1 1/2"

Hook No.	Size
RM812	1 1/4" x 2 1/4"

Base Metals: Brass, stainless steel (select products - see price list for availability)

Our collection of coat hooks is a sturdy alternative to more common fare. Most architectural finishes are available. Standard attachment hardware is for wood doors. Specify if you are using on metal or glass doors.

Coat Hooks

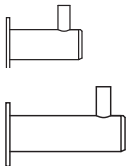
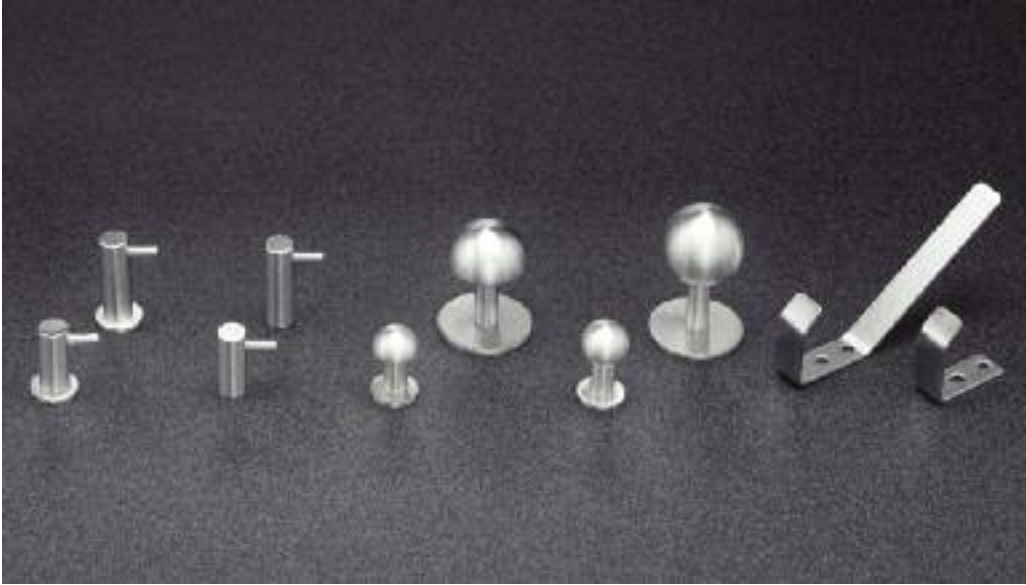

Coat Hooks

Hook No.	Size
RM820	½" x 1½"
RM821	½" x 2½"

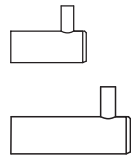

Hook No.	Size
RM822	½" x 1½"
RM823	½" x 2"

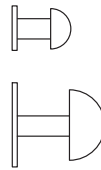

Hook No.	Size
RM824	1" x 1⅞"
RM825	1¾" x 2½"

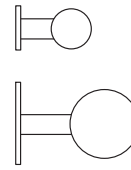

Hook No.	Size
RM826	1" x 1⅞"
RM827	1¾" x 3⅜"

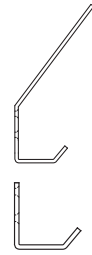

Hook No.	Size
RM828	¾"W x 2⅞"
RM829	¾"W x 1⅞"

Base Metals: Brass, stainless steel (select products - see price list for availability)

Our collection of door stops features our DuraFlex bumper material that outlasts other manufacturers' rubber bumpers many times over. It stays resilient and colorfast for years. These new styles offer solutions for wall, floor and baseboard stops. The door stops are available in most architectural finishes.

Door Stops

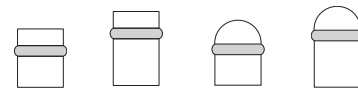

Floor Mounted Stops

Stop No.	Description	Base	Projection
RM850	Short-Square Top	1½"	1½"
RM851	Tall-Square Top	1½"	2½"
RM855	Short-Round Top	1½"	1½"
RM856	Tall-Round Top	1½"	2¾"



Wall Mounted Stops

Stop No.	Bumper	Base	Projection
RM860	Convex	1½"	1½"
RM861	Concave	1½"	1½"

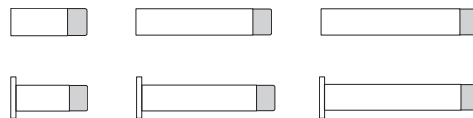

Base Board Mounted Stops

Stop No.	Base Plate	Base	Projection
RM870	No	¾"	1½"
RM871	No	¾"	3¼"
RM872	No	¾"	3¼"
RM875	Yes	1"	1½"
RM876	Yes	1"	3¼"
RM877	Yes	1"	3¼"

Base Materials: Brass, stainless steel

Rockwood offers a selection of push and pull plates hand finished in our factory to match our pulls. All plates are .050" thick and available in screw or adhesive mounting. Custom engraved signs and plates are readily available.

Push Plates, Pull Plates & Signage

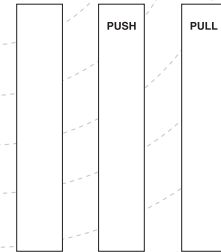
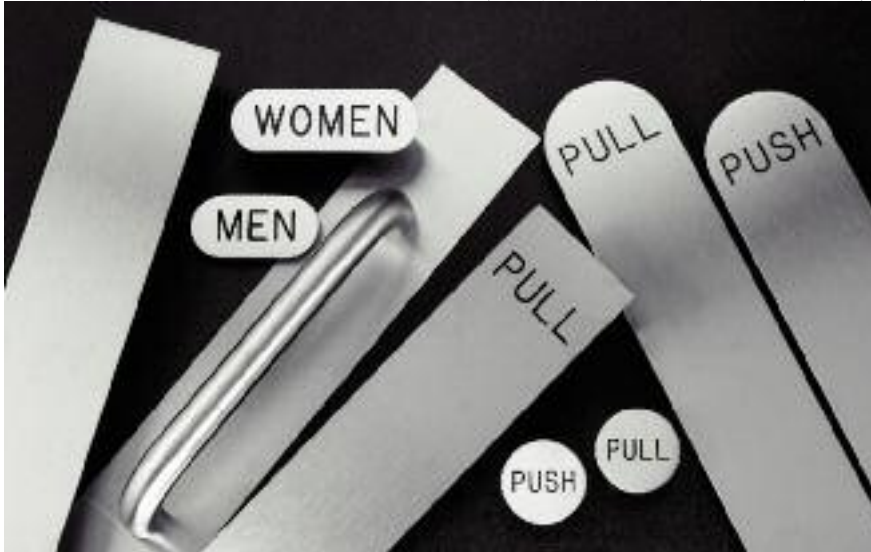

Push and Pull Plates – Square Corners Adhesive Mount

Plate No.	Engraved	Size
RM1010	Blank	4" x 22"
RM1010H	PUSH	4" x 22"
RM1010L	PULL	4" x 22"

Add pull # to completely specify pull plate. Any size made to order.

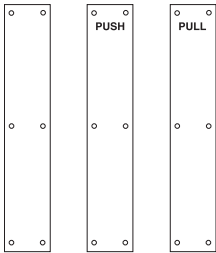

Push and Pull Plates – Square Corners Screw Mount

Plate No.	Engraved	Size
RM1020	Blank	4" x 22"
RM1020H	PUSH	4" x 22"
RM1020L	PULL	4" x 22"

Add pull # to completely specify pull plate. Any size made to order.

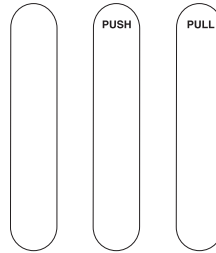

Push and Pull Plates – Radius Ends Adhesive Mount

Plate No.	Engraved	Size
RM1030	Blank	4" x 22"
RM1030H	PUSH	4" x 22"
RM1030L	PULL	4" x 22"

Add pull # to completely specify pull plate. 4" width by any length made to order.

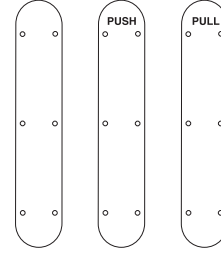

Push and Pull Plates – Radius Ends Screw Mount

Plate No.	Engraved	Size
RM1040	Blank	4" x 22"
RM1040H	PUSH	4" x 22"
RM1040L	PULL	4" x 22"

Add pull # to completely specify pull plate. 4" width by any length made to order.



Indicator Plates - Adhesive Mount

Plate No.	Engraved	Diameter
RM1110H	PUSH	1"
RM1110L	PULL	1"
RM1120H	PUSH	2½"
RM1120L	PULL	2½"



Indicator Plates

Plate No.	Engraved	Size	Mounting
RM1150M	MEN	2" x 4"	Adhesive
RM1150W	WOMEN	2" x 5¼"	Adhesive
RM1160M	MEN	2" x 4"	Screw
RM1160W	WOMEN	2" x 5¼"	Screw

Matching custom signs readily available.

Base Materials: Brass, bronze, stainless steel

Our offset pivots are precision manufactured for smooth operation and durability. They are available in standard duty or heavy duty versions in configurations for most applications. See our Architectural Hardware catalog for more styles and ordering information.

Custom Pivots

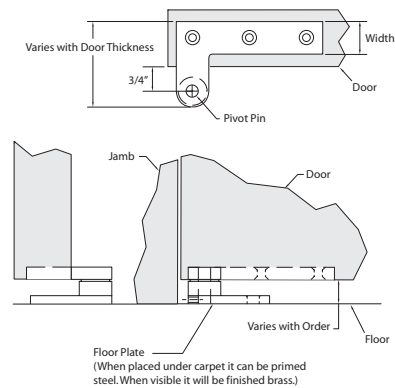
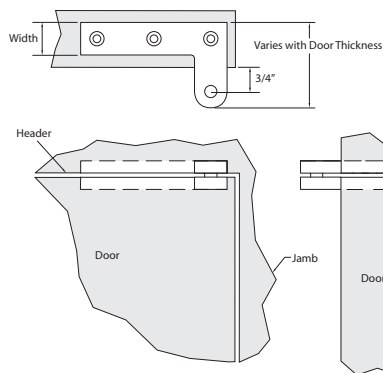

Standard Head Pivots

Pull No.	Width	Material Size
CP10	1"	3/8" thick for doors up to 200 lbs.
CP10HD	1"	1/2" thick for doors over 200 lbs.
CP20	7/8"	3/8" thick for doors up to 200 lbs.
CP20HD	7/8"	1/2" thick for doors over 200 lbs.

Standard Floor Pivots

Pull No.	Width	Material Size
CP40	1"	3/8" thick for doors up to 200 lbs.
CP40HD	1"	1/2" thick for doors over 200 lbs.
CP50	7/8"	3/8" thick for doors up to 200 lbs.
CP50HD	7/8"	1/2" thick for doors over 200 lbs.

Base Materials: Brass

Custom Capabilities

Custom Bending



Custom Casting



Corporate Identity



Custom Machining

Leather Craftsmanship General Information

Custom Manufacturing: The leather craftsmanship shown in the photographs opposite expresses our capabilities in leather covering. We apply equal expertise to our door pull fabrication. Rockwood is dedicated to making the door hardware you want. Please don't hesitate to ask for minor design or size changes to existing products or completely custom creations.

Maintenance: Upholstery Leather has a breathable protective finish that is best cleaned by wiping with a cool damp cloth. For tougher soiling, use a pH balanced soap on a cloth and rinse. Always use cool water. Repeat if necessary. Do not use wax, mink oil, saddle soap or polishes on upholstery leather. Leather Maintenance Kits are available from the factory.

English Bridle Leather leaves our factory with a coat of Sedgwick Leathercare Product, a mixture of natural oils, fats and beeswax. Clean the leather as necessary with a damp cloth and allow to dry. Apply a light coat of leather care product, allow to dry and buff with a soft cloth. Additional Sedgwick Leathercare Product is available from the factory.

Finishes: This catalog features product photographs of leather wrapped stainless steel door pulls. We also make many of these products in brass and bronze base material with a variety of architectural finishes.

Standard Color Selections

English Bridle Leather

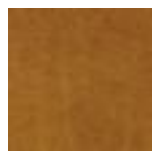

B-LBRN
(Light Brown)

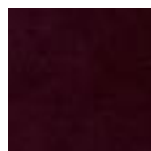

B-BUR
(Burgundy)



B-MBRN
(Medium Brown)



B-DBRN
(Dark Brown)



B-BLK
(Black)

Upholstery Leather

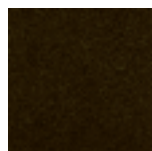

U-DBRN
(Dark Brown)



U-BLK
(Black)

Leather: Rockwood uses Bridle leather produced by J & E Sedgwick & Co., Ltd., Walsall, England. Founded in 1900, Sedgwick is renowned for its high quality leather products. Their 8-ounce hand-colored vegetable tanned English Bridle leather enjoys the reputation of being the finest in the world; you can be assured of a beautiful, durable leather door pull. For more information on Sedgwick leathers visit their website at www.je-sedgwick.co.uk.

In addition to our selection of fine English Bridle and Upholstery leathers, you may specify a custom leather application. We recommend Spinneybeck as a source for custom leather applications; see www.spinneybeck.com. Minimum charges apply for special order leather.

Leather Craftsmanship





English Bridle leather pulls are beautifully crafted in a variety of colors and styles. Detail end stitching compliments the tight fitting leather cover. The sewn seam on the back of the pull is a work of art itself. Typically used for saddles and other equestrian products, this smooth durable leather is suitable for both interior and exterior applications. A full wrap version is available on square end pulls. See page 86 for leather color selection and more information.

English Bridle Leather

straight & offset pulls

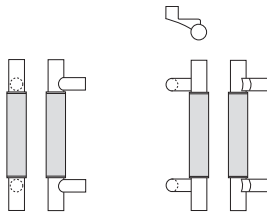

Pulls - Square Ends

Pull No.	Post	Diameter*	CTC
RM6000	Straight	1"	10", 12"
RM6010	Straight	1½"	12", 16"
RM6020	Straight	1½"	12", 16"
RM6030	Offset	1"	10", 12"
RM6040	Offset	1½"	12", 16"
RM6050	Offset	1½"	12", 16"

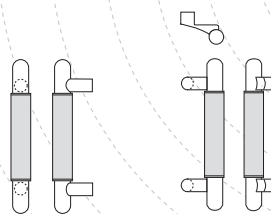

Pulls - Round Ends

Pull No.	Post	Diameter*	CTC
RM6004	Straight	1"	10", 12"
RM6014	Straight	1½"	12", 16"
RM6024	Straight	1½"	12", 16"
RM6034	Offset	1"	10", 12"
RM6044	Offset	1½"	12", 16"
RM6054	Offset	1½"	12", 16"

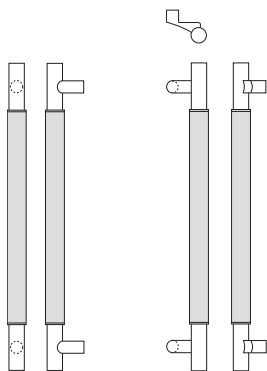

Long Pulls - Square Ends

Pull No.	Post	Diameter*	Overall
RM6060	Straight	1"	36" to 96"
RM6061	Straight	1½"	36" to 96"
RM6062	Straight	1½"	36" to 96"
RM6070	Offset	1"	36" to 96"
RM6071	Offset	1½"	36" to 96"
RM6072	Offset	1½"	36" to 96"

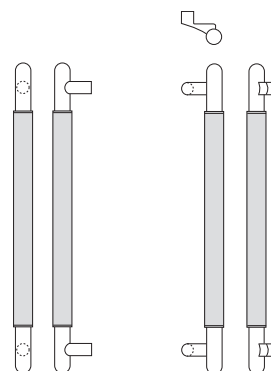

Long Pulls - Round Ends

Pull No.	Post	Diameter*	Overall
RM6080	Straight	1"	36" to 96"
RM6081	Straight	1½"	36" to 96"
RM6082	Straight	1½"	36" to 96"
RM6090	Offset	1"	36" to 96"
RM6091	Offset	1½"	36" to 96"
RM6092	Offset	1½"	36" to 96"



Optional FW

Base Metal: Brass, bronze, stainless steel

Options:

- For optional mid-post, suffix the product number with "MP" (example: RM6061MP).
- Full wrap option is available up to 72" long (example: RM6061FW).
- Over 96" available on select finishes.

Note: Maximum leather length is 72".

* Diameter of metal grip, leather thickness is about ⅛" additional.



Upholstery leather pulls are available in two standard colors or from a universe of custom leather. We use 3 to 4 ounce chrome tanned leather, tightly wrapped and neatly sewn along the back. Detail end stitching compliments this glove soft leather which is suitable for interior applications. See page 86 for leather color selection and more information.

Upholstery Leather

straight & offset pulls

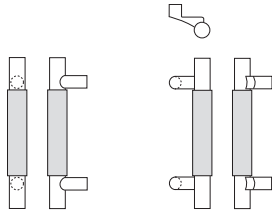

Pulls - Square Ends

Pull No.	Post	Diameter*	CTC
RM6100	Straight	1"	10", 12"
RM6110	Straight	1½"	12", 16"
RM6120	Straight	1½"	12", 16"
RM6130	Offset	1"	10", 12"
RM6140	Offset	1½"	12", 16"
RM6150	Offset	1½"	12", 16"

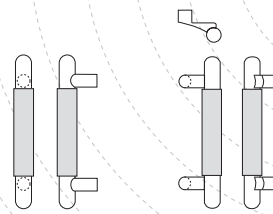

Pulls - Round Ends

Pull No.	Post	Diameter*	CTC
RM6104	Straight	1"	10", 12"
RM6114	Straight	1½"	12", 16"
RM6124	Straight	1½"	12", 16"
RM6134	Offset	1"	10", 12"
RM6144	Offset	1½"	12", 16"
RM6154	Offset	1½"	12", 16"

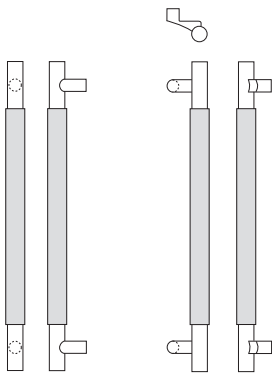

Long Pulls - Square Ends

Pull No.	Post	Diameter*	Overall
RM6160	Straight	1"	36" to 96"
RM6161	Straight	1½"	36" to 96"
RM6162	Straight	1½"	36" to 96"
RM6170	Offset	1"	36" to 96"
RM6171	Offset	1½"	36" to 96"
RM6172	Offset	1½"	36" to 96"

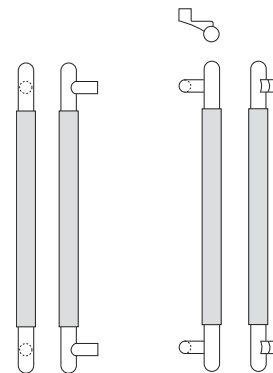

Long Pulls - Round Ends

Pull No.	Post	Diameter*	Overall
RM6180	Straight	1"	36" to 96"
RM6181	Straight	1½"	36" to 96"
RM6182	Straight	1½"	36" to 96"
RM6190	Offset	1"	36" to 96"
RM6191	Offset	1½"	36" to 96"
RM6192	Offset	1½"	36" to 96"

Base Metal: Brass, bronze, stainless steel

Options: • For optional mid-post, suffix the product number with "MP" (example: RM6161MP).
• Over 96" available on select finishes.

Note: Maximum leather length is 72".

* Diameter of metal grip, leather thickness is about ⅛" additional.



Our expertly fitted and sewn leather is available in a flush wrap style. The clean lines of this model create a classic design shown here in black English Bridle leather. The leather fits neatly into the surface of the metal grip providing a smooth transition to solid metal ends and the comfortable feel of genuine leather. It is available in both English Bridle and Upholstery leather in a variety of colors. See page 86 for leather color selection and more information.

Flush Leather

straight & offset pulls

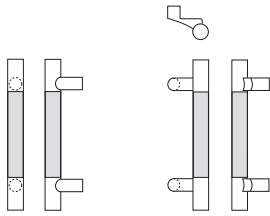

Pulls - Square Ends

Pull No.	Post	Diameter	CTC*
RM6300	Straight	1"	10", 12"
RM6310	Straight	1½"	12", 16"
RM6320	Straight	1½"	12", 16"
RM6330	Offset	1"	10", 12"
RM6340	Offset	1½"	12", 16"
RM6350	Offset	1½"	12", 16"

Up to 96" CTC available with mid-post.

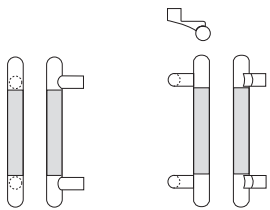

Pulls - Round Ends

Pull No.	Post	Diameter	CTC*
RM6304	Straight	1"	10", 12"
RM6314	Straight	1½"	12", 16"
RM6324	Straight	1½"	12", 16"
RM6334	Offset	1"	10", 12"
RM6344	Offset	1½"	12", 16"
RM6354	Offset	1½"	12", 16"

Up to 96" CTC available with mid-post.

Application Suggestions

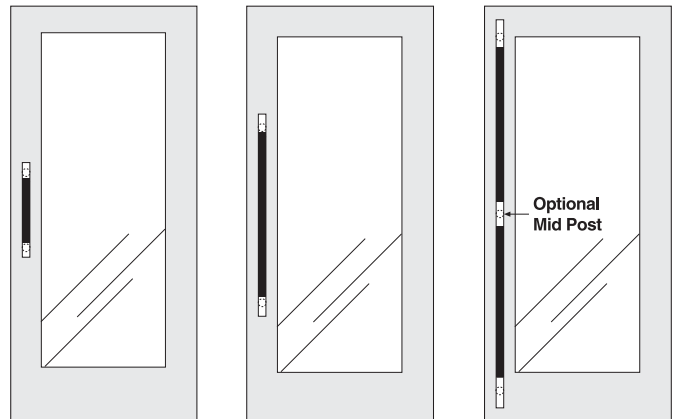

Base Metal: Brass, bronze, stainless steel
Options: Over 96" available on select finishes.



Our smooth durable English Bridle leather and glove soft Upholstery leather are available on our ergonomically agreeable oval and flat oval shape pulls. We make these pulls in both standard and full height sizes. Leather wrapping options include partial and full wrap. See page 86 for leather color selection and more information.

Leather Oval

ergonomic pulls

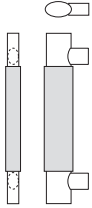

Straight Oval

Pull No.	Post	Grip Size*	CTC**
RM6200	oval	1" x 1½"	12", 16"

Up to 96" CTC available.

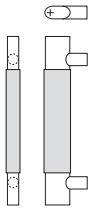

Flat Oval - Small Post

Pull No.	Post	Grip Size*	CTC**
RM6220	¾"	¾" x 1½"	12", 16"

Up to 96" CTC available.

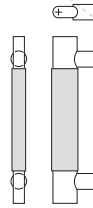

Flat Oval - Large Post

Pull No.	Post	Grip Size*	CTC**
RM6230	1"	¾" x 1½"	12", 16"

Up to 96" CTC available.

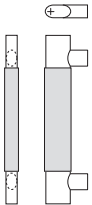

Flat Oval - Oblong Post

Pull No.	Post	Grip Size*	CTC**
RM6240	¾" x 1½"	¾" x 1½"	12", 16"

Up to 96" CTC available.

Application Suggestions

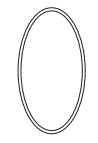
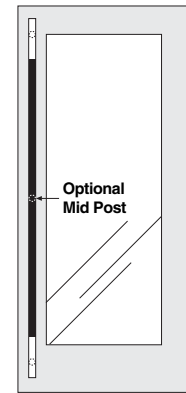
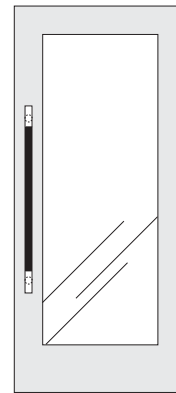
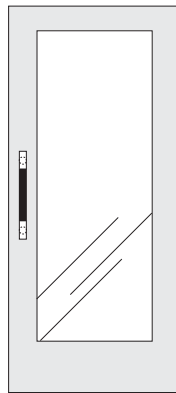

Oval Detail

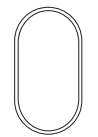

Flat Oval Detail

Other Length Ordering Options

Specify a mid-post on full height pulls to provide the most rigid grip where heavy doors or high wind loads are present.

Base Metal: Stainless steel

Options: Over 96" available on select finishes.

* Size of metal grip, leather thickness is about ⅛" additional.

** Standard overall length is 4" greater than CTC for pulls up to 36" CTC, and 6" greater than CTC for pulls 36" CTC and larger. Maximum leather length is 72".

The glove soft Upholstery Leather and durable smooth English Bridle Leather (shaved thin to fit small diameter grips) provide a refined finish detail beyond comparison. Available in a variety of colors, see page 86 for color specifications.

Small Leather Pulls

for cabinets, casework and closet doors

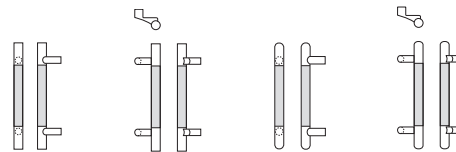
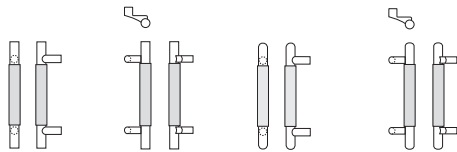

Surface Wrapped

Pull No.	Post	End	Diameter	CTC*
RM6500	Straight	Square	½"	4", 5"
RM6510	Straight	Square	⅝"	5", 6"
RM6530	Offset	Square	⅝"	5", 6"
RM6540	Straight	Round	½"	4", 5"
RM6550	Straight	Round	⅝"	5", 6"
RM6570	Offset	Round	⅝"	5", 6"

Flush Wrapped

Pull No.	Post	End	Diameter	CTC*
RM6610	Straight	Square	⅝"	5", 6"
RM6630	Offset	Square	⅝"	5", 6"
RM6650	Straight	Round	⅝"	5", 6"
RM6670	Offset	Round	⅝"	5", 6"

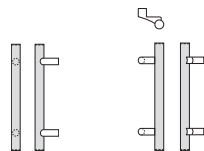

Full Wrapped - Square End (Bridle Leather only)

Pull No.	Post	Diameter	CTC*
RM6700	Straight	½"	4", 5"
RM6710	Straight	⅝"	5", 6"
RM6730	Offset	⅝"	5", 6"

Base Metal: Brass, stainless steel

Mounting: 8-32 x 1 THMS (Standard drawer thickness is ¾"; advise if other than ¾")

*Any size made to order.

© 2006 Rockwood Manufacturing Company

There are limitless varieties of leather designs and colors. This photo shows only a few examples. Most door pulls from our Architectural Door Pull catalog can be leather covered as well. Our experienced staff is available to work with you to create a pull that meets the needs of your situation. Please call our office with your inquiry.

Custom Leather Applications





ROCKWOOD

ASSA ABLOY

P.O. Box 79
Rockwood, Pennsylvania 15557
(800) 458 2424 Phone
(800) 922 9212 Fax
www.rockwoodmfg.com
info@rockwoodmfg.com